

ADDAC System
 Instruments for Sonic Expression
 Est.2009

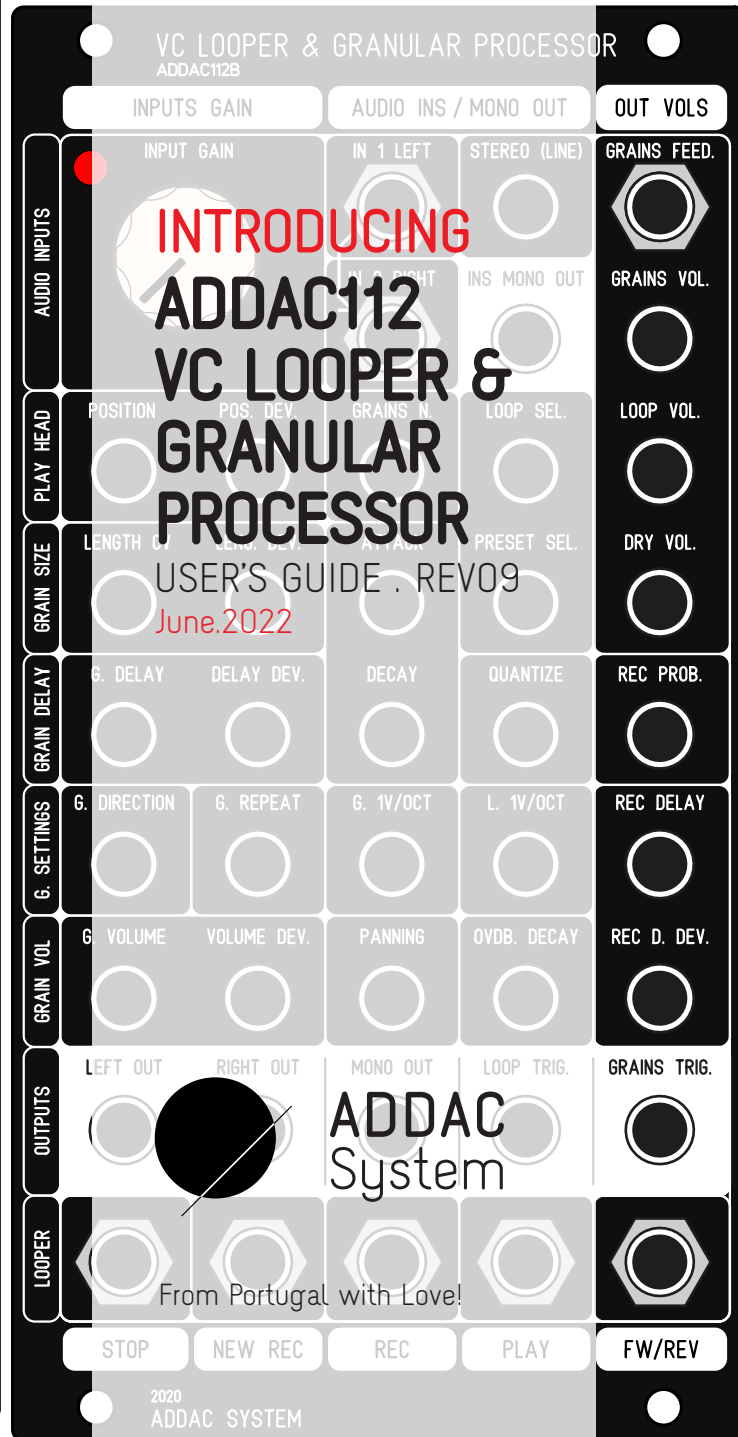
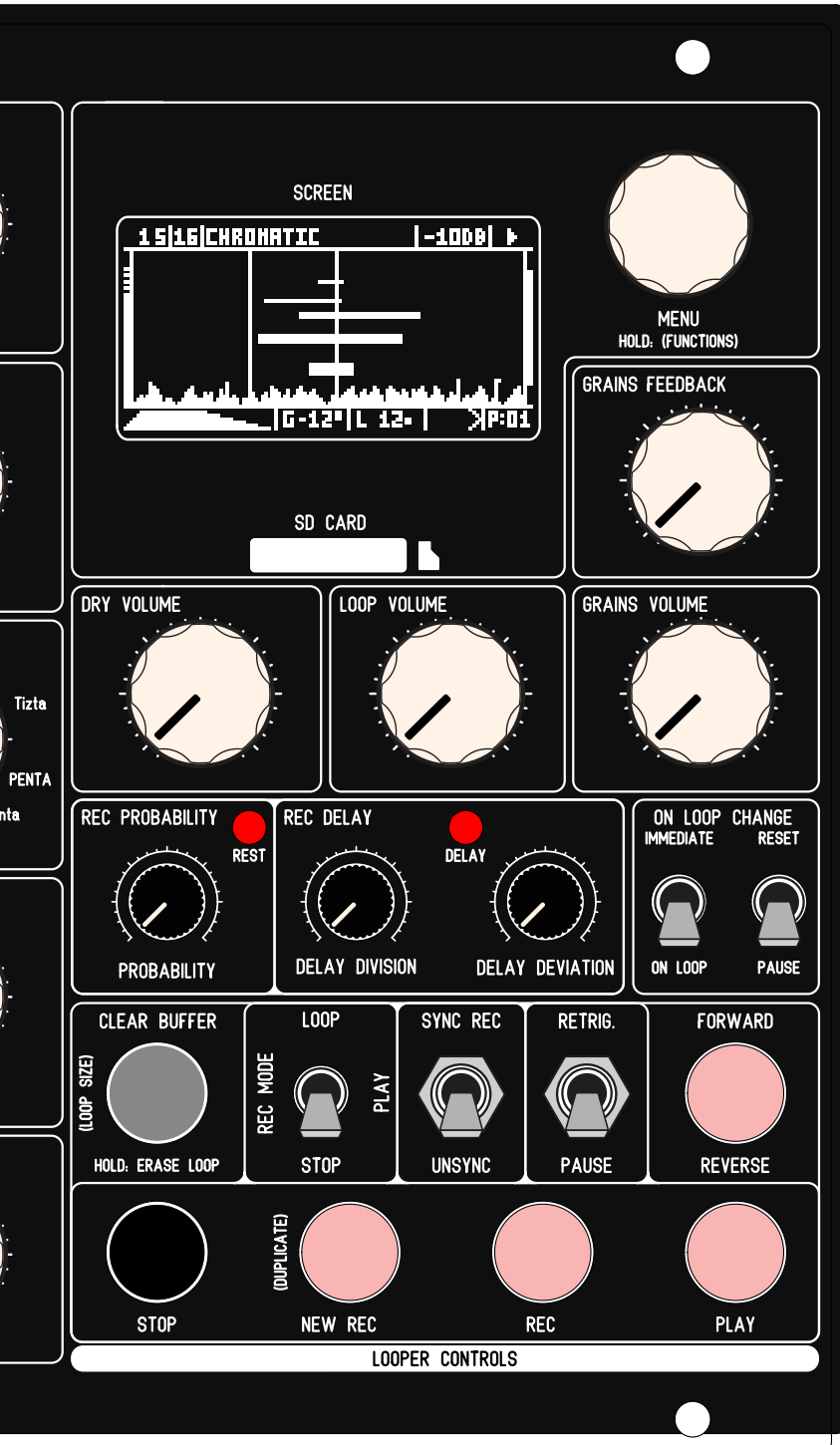

Welcome to: ADDAC112 VC LOOPER & GRANULAR PROCESSOR

USER'S GUIDE

Revision.09 June.2022

WELCOME

There's a long history behind the granular concept and many reinterpretations of it's core principles, this is our take on it.

In a loose description digital Granular refer to pieces of sound files being played at the same time with slight or completely different parameters originating what is commonly referred to as granular clouds. Normally there's a buffer size from which the granular engine snips it's pieces from and plays them according to the parameters set. This buffer size is normally small in size where grains are so small that can reach the hearing spectrum and be heard as a sort of ever changing complex wavetable, this is the principle behind granular synthesis.

In our vision we added the possibility of long buffer sizes up to 5 minutes, allowing "softer" approaches to the granular principle using it as an effect that can generate from "accidental" effects like slight "stutters" to extreme processing and transformation of any incoming audio signal.

This module is conceptually deep but easy to grasp and operate as all controls are in it's dedicated panel, all jack inputs and outputs have it's own separate panel to allow no compromise when playing it's controls.

Some info stated in this document is still subject to change as new firmwares are released.

32HP

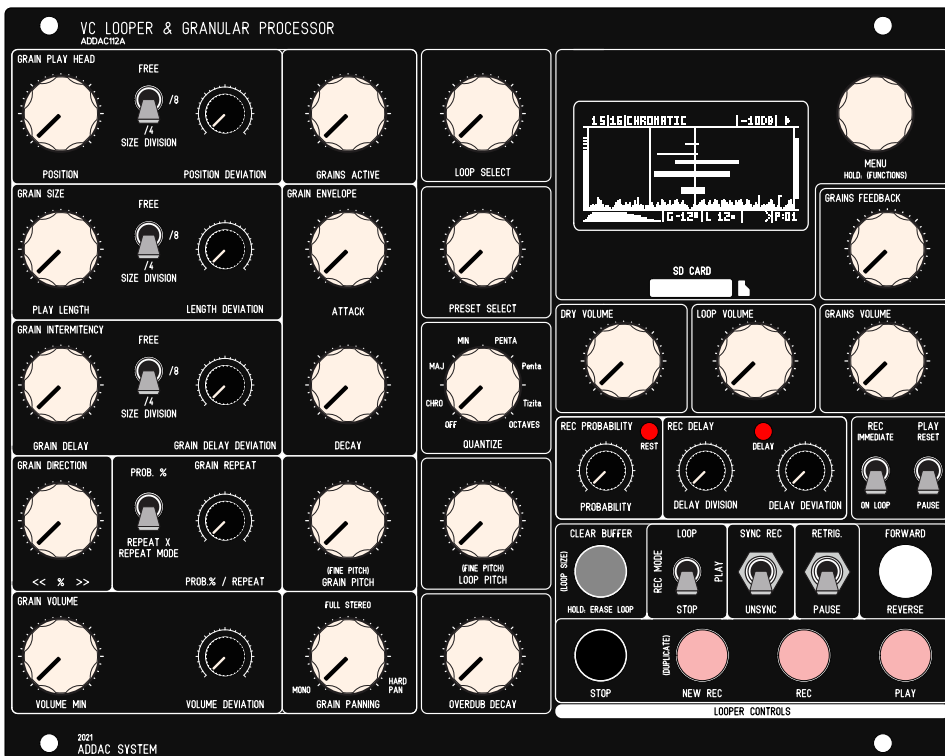

13HP

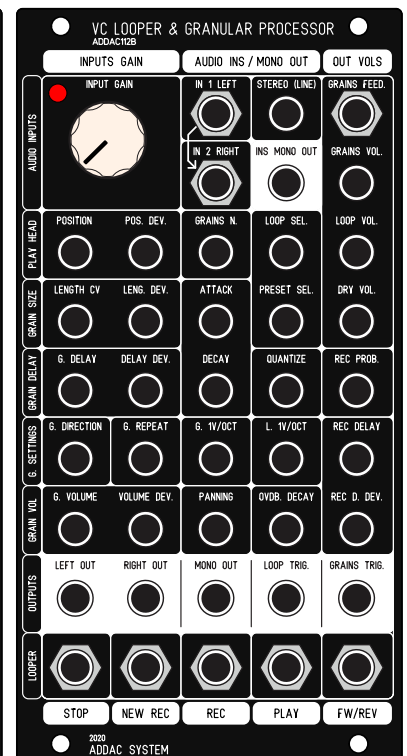

For the first time we sacrificed the module width to leave more space between controls.

DESCRIPTION

There are three main sections in this module:

Looper Engine:

The Looper is where all the Real-Time recording happens.

The audio input feeds the recording buffer, multiple controls allow to record and play loops into a list so that any sample in the list can be accessed at any time and more acting as a standard looper

Granular Engine:

The Granular acts upon the buffer of whatever LOOP is selected.

Output Mix

The output mix allow individual control for the Dry Input, Looper Volume and Grains Volume.

Besides these main sections there's also a simple strip down MENU mainly used to LOAD and SAVE Banks, no Menu diving guaranteed.

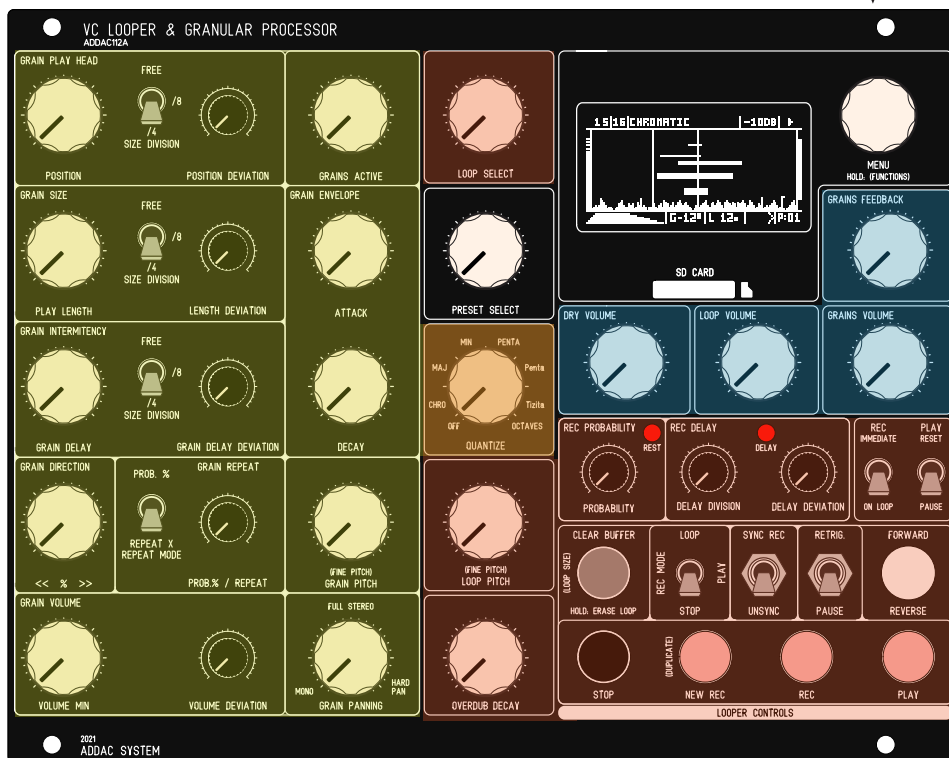

Audio Specs:

Stereo audio input and output
 32-bit floating point DSP
 Bit Depth: 8 or 16bit
 Sample Rates: 8Khz, 11.025Khz, 16Khz, 22.05Khz, 36Khz,
 44.1Khz, 48Khz 96Khz

Tech Specs:

32HP + 13HP
 4.5cm deep
 240mA +12V
 70mA -12V

RIBBON CONNECTIONS

!!! WARNING !!! - !!! RED STRIPE DOWN ON ALL CONNECTORS !!!
Also notice the indentation of the boxed headers!

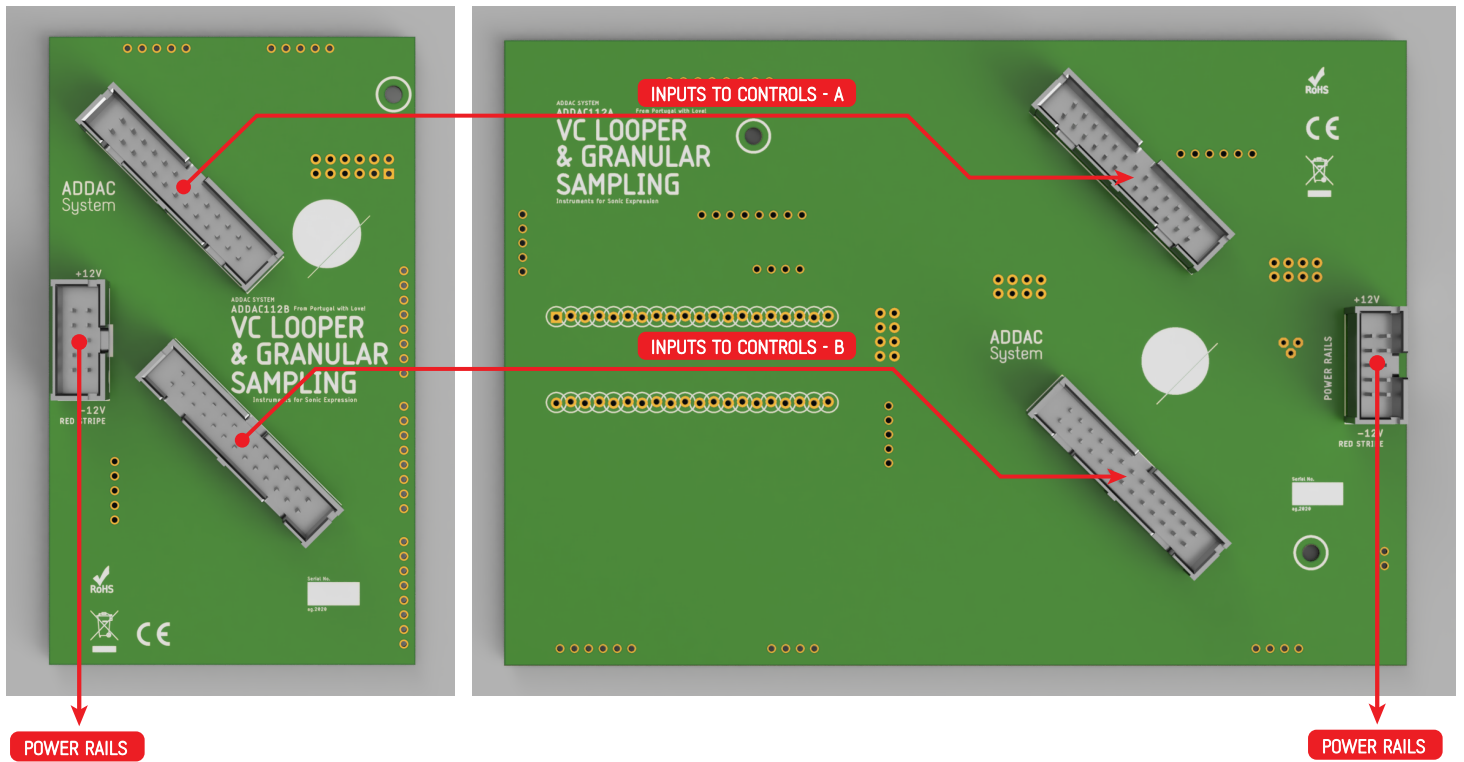

BANKS and PRESETS

BANKS:

In order to make the LOAD/SAVE process simple one can only LOAD BANKS from the SD Card. BANKS contain a list of PRESETS and a folder with a list of LOOPS.

Each BANK is saved into a folder in the SD CARD, inside the folder, together with a document containing all presets configurations, the user will find a second folder with all LOOPS in separate WAV files.

While Saving or Loading from the SD Card the audio processing will be suspended, it may take up to 10 seconds to save a full Bank.

Once the BANK is loaded to memory jumping between LOOPS will be immediate.

A new BANK can be created at any time using the MENU: NEW BANK.

BANKS initialize with an empty list of PRESETS and LOOPS.

At the moment of creating a new BANK the user will be asked to choose from 2 options:

1. Current Config, copies the current BANK settings into the new BANK
2. Default Config, creates a new BANK with factory default settings.

Powering up the module without any SD Card will automatically create a new Bank, this Bank will be initialized with factory default settings.

Each BANK stores a list of up to 99 PRESETS as well as all loops used by all these PRESETS.

Upon startup the module will automatically load the last BANK saved.

All recording is written and read from volatile memory if the BANK is not saved to the SD Card all data will be lost once a new BANK is loaded or power is turned off!

Users can share Banks among themselves by sharing the Bank folder.

PRESETS:

Each PRESET contains a list of LOOPS and all Granular Settings.

Each PRESET can have shared or unique LOOP lists.

PRESETS can be saved at any time using the MENU: SAVE PRESET

PRESETS can be added to the list using the MENU: NEW PRESET, this new PRESET will be created with the current Granular settings.

As PRESETS are changed via the [PRESET SELECT] control knobs will not reflect the current values of the front panel controls and, in this case, they will seem not to have any effect, to make them effective once again the user must rotate the knob until it crosses the preset setting and then the knob will become active once again.

At all times rotating the [PRESET SELECT] to the left most position will enter preset "-" in this state all knobs always correspond to the front panel controls.

LOOPS

LOOPS:

A list of .WAV files up to 99 files per BANK

LOOPS can be added to a folder using a computer or recorded in real-time using the LOOPER Engine. aprox. 60Mb of maximum sampling time shared for all loops in a BANK.

Recording time will be diferent depending on the Sample Rate selected, as a reference at 44.1Khz will allow for 11:40 minutes (MONO) or 5:50 minutes (STEREO).

Loops recorded using the module Looper Engine will either be Mono or Stereo and have the Sample Rate and Bit Depth defined by the settings chosen in the module's options menu, default setting is Stereo 44.1K 16 bit.

The total ammount of recording time will depend on these 3 settings: Channels number, Sample Rate and Bit Depth.

LOOPS & PRESETS Can be Accessed in real-time with the dedicated [LOOP SELECT] & [PRESET SELECT] knobs and/or CV inputs.

If new LOOPS or PRESETS are recorded at any point in time remember that they are not yet saved to the SD Card, saving the current BANK before loading a new BANK or before power down is necessary to keep all it's contents safe in the SD Card!

SD CARD FILE STRUCTURE

At the Root of the SD Card any folder named "BANK" proceeded by a number will be eligible to be loaded. To create a new BANK directly on the SD Card simply create a new folder and name it, for example: BANK1. Next, inside this BANK1 folder, create another folder named "WAV", inside this WAV folder put any number of .wav files as long as the whole folder is below 60Mb.

Loops indexation will respect the number at the start of the file name, if no number is present the file name will be renamed by the module and a number at the start will be automatically attributed. Manually changing these numbers on a computer will change the order by which they are selected by the [LOOP SELECT].

BANK Folders are named "BANK" proceeded by a number, after the number the user can use more characters to label the bank and make it easier to identify it when loading the bank on the module. BANK naming examples below.

Saving a Bank on the module will add extra files:
 SETTINGS.CFG stores the main configuration settings
 SCALES.CFG stores the Quantization scales both Default and Custom
 X.CFG stores all presets settings
 DELETED folder stores all deleted loops

SD CARD STRUCTURE	Description:
- GLOBAL.CFG	> AUTOLOAD BANK FILE
- BANK0 MyFirstSet	> BANK0 FOLDER
- BANK1NiceOne	> BANK1 FOLDER
- BANK2_vcoWaves	> BANK2 FOLDER
- SETTINGS.CFG	> BANK SETTINGS FILE
- SCALES.CFG	> SCALES FILE
- 0.CFG	> PRESET 0 CONFIG FILE
- 1.CFG	> PRESET 1 CONFIG FILE
- 2.CFG	> PRESET 2 CONFIG FILE
- 3.CFG	> PRESET 3 CONFIG FILE
- DELETED	> DELETED FILES FOLDER
- 6.WAV	- 1st file in index
- 7.WAV	- 2nd file in index
- WAV	> WAV FILES FOLDER
- 1_MYLONGFILE.WAV	- 1st file in index
- 2_MYSHORTLOOP.WAV	- 2nd file in index
- 3_ANOTHERLOOP.WAV	- 3rd file in index
- 4_ONEMOREFILE.WAV	- 4th file in index
- 5_LOOP234.WAV	- 5th file in index
- BANK3 AcousticSET	> BANK3 FOLDER
	> ...

.WAV FILES

When adding .WAV files to the SD Card from a computer it's important that the files have clean .WAV headers and **NO METADATA**, some softwares can export without adding extra data to the file.

If errors are shown or if files are not loaded correctly you can always use a batch media converter like MediaHuman to automate and make this task a simple process:

<https://www.mediahuman.com/download.html>

DEVIATION

DEVIATION is used throughout this guide to refer to a deviation from the Initial knob. There are TWO operation modes for this setting:

RANDOM MODE

In this mode Deviation is a random function kept inside a range based on a percentage spread centered on the Initial knob setting. This keeps all random values inside the main range of the knob never going above or below the range limits eliminating "dead spots".

The examples below will graphically exemplify this concept:

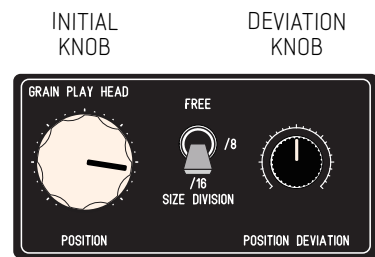
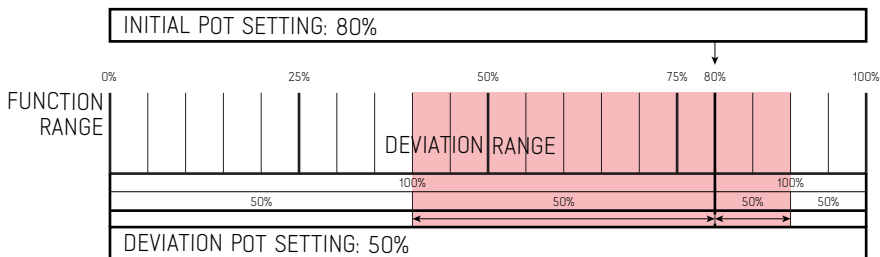
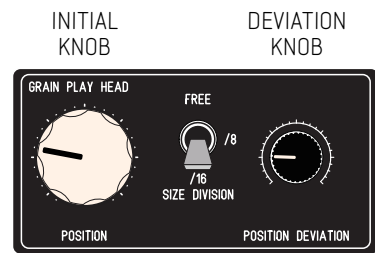
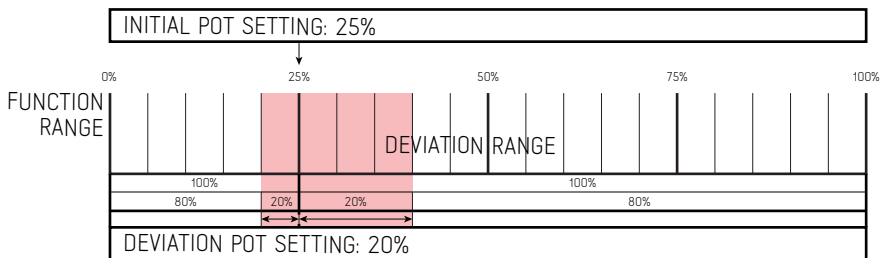
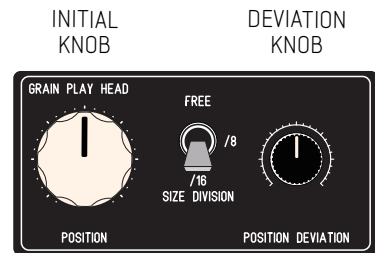
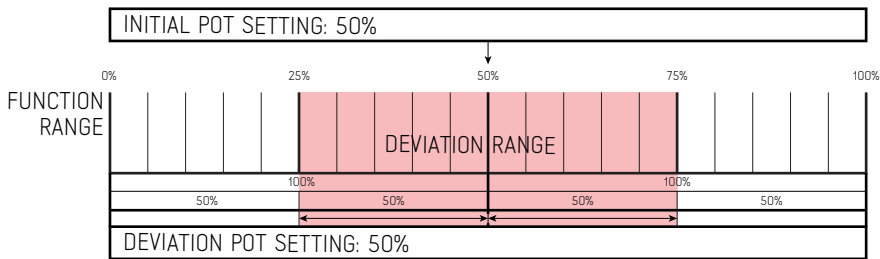

DEVIATION

SPREAD MODE - [GRAIN PLAY HEAD] [GRAIN SIZE] [GRAIN INTERMITENCY]

In this mode Deviation sets an increment used to spread the corresponding function over the grains index.

Grain 1 always keep the initial settings without any increment.

This mode will work best for longer loops 10 - 20 - 40 seconds or more.

The examples below will graphically exemplify this concept applied to [GRAIN PLAY HEAD] and [GRAIN SIZE] (although not shown below [GRAIN INTERMITENCY] follows the same principles):

Example A:

Position at 10% - Position Deviation at 5%

Length at 10% - Length Deviation at 5%

GRAINX: POS <-> ABSOLUTE(INITIAL POSITION + DEVIATION

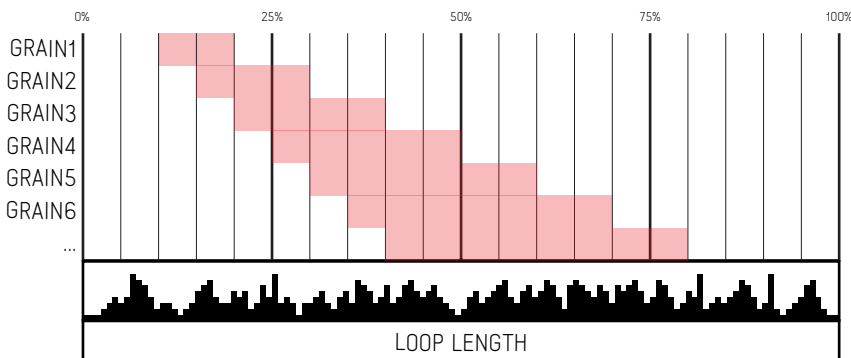

GRAIN1: POS:10% / LENGTH:10%
 GRAIN2: POS:10% + (5%*1)=15% | LENGTH:10% + (5%*1)=15%
 GRAIN3: POS:10% + (5%*2)=20% | LENGTH:10% + (5%*2)=20%
 GRAIN4: POS:10% + (5%*3)=25% | LENGTH:10% + (5%*3)=25%
 GRAIN5: POS:10% + (5%*4)=30% | LENGTH:10% + (5%*4)=30%
 GRAIN6: POS:10% + (5%*5)=35% | LENGTH:10% + (5%*5)=35%
 GRAIN7: POS:10% + (5%*6)=40% | LENGTH:10% + (5%*6)=40%

Example B:

Position at 10% - Position Deviation at 0%

Length at 30% - Length Deviation at 30%

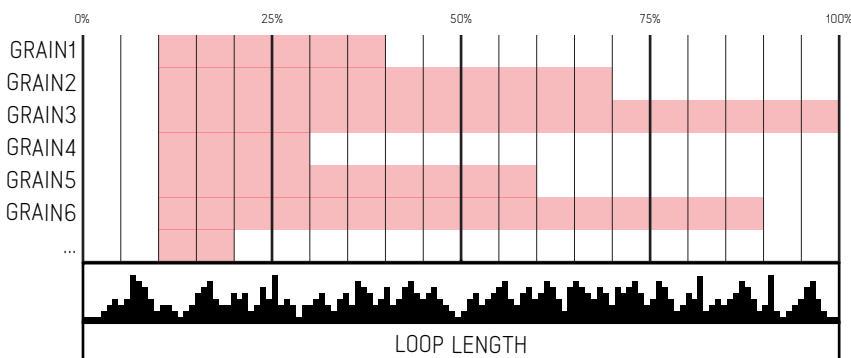

START LENGTH	+INC	TOTAL LENGTH	START POSITION	END POSITION
30%	0	0%	10%	40%
30%	30	60%	10%	70%
30%	60	90%	10%	100%
30%	90	120% 20%	10%	30%
30%	120	150% 50%	10%	60%
30%	150	180% 80%	10%	90%
30%	180	210% 10%	10%	20%

WRAP AROUND 100%*

*Wrap around is a modulus operation which, simply put, means no value can be greater than 100% and if so it will simply read the two lowest numbers, ex: 110% - 10%

DEVIATION

SPREAD MODE - [GRAIN VOLUME]

In this mode [VOLUME DEVIATION] sets an increment used to spread the volume over the grains index.

Grain 1 always keep the [VOLUME MIN] setting without any increment.

The [VOLUME DEVIATION] knob will be at 0% at 12 o'clock, going counter clockwise will subtract, clockwise will sum.

Example A:
Volume Min at 60% - Volume Deviation at +15%

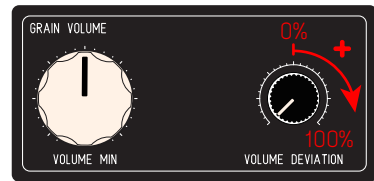
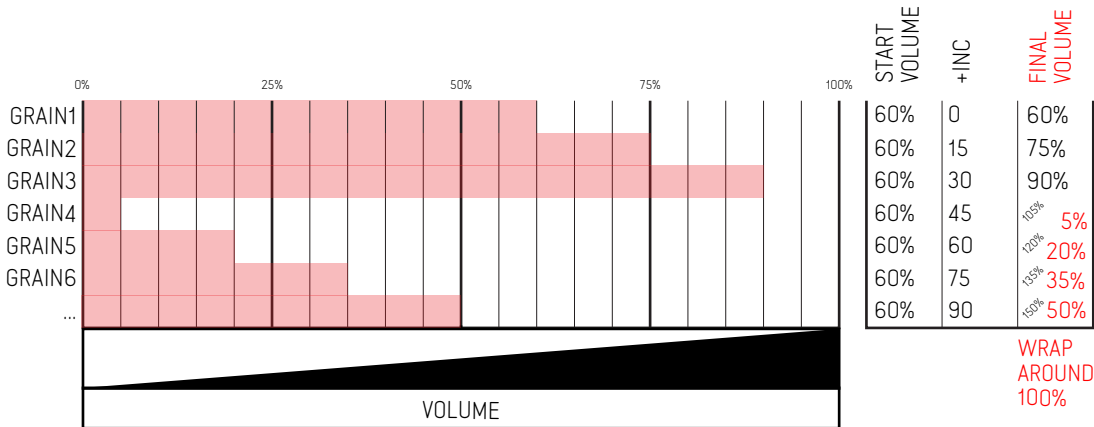

Example B:
Volume Min at 90% - Volume Deviation at -25%

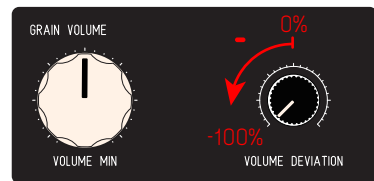
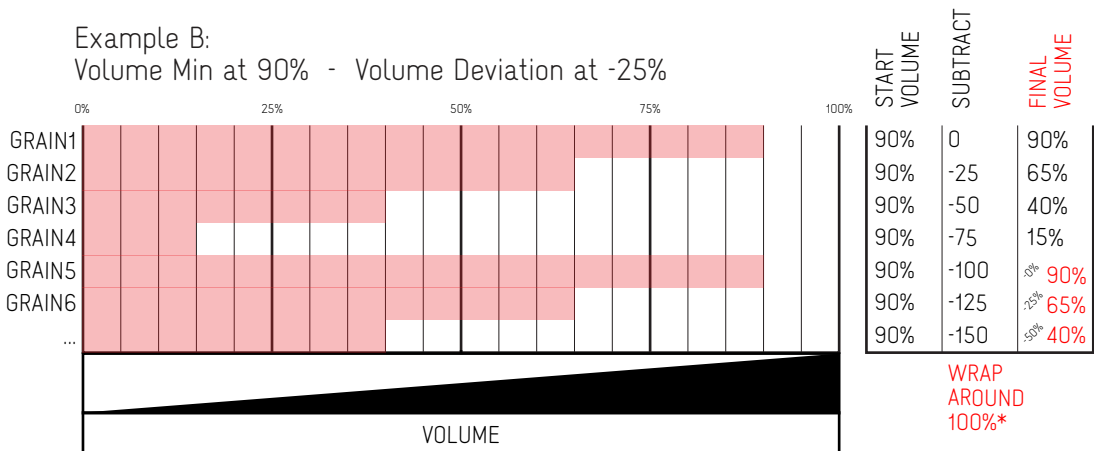

*Wrap around is a modulus operation which, simply put, means no value can be greater than 100% and if so it will simply read the two lowest numbers. ex: 110% - 10%

SIGNAL FLOW DIAGRAM

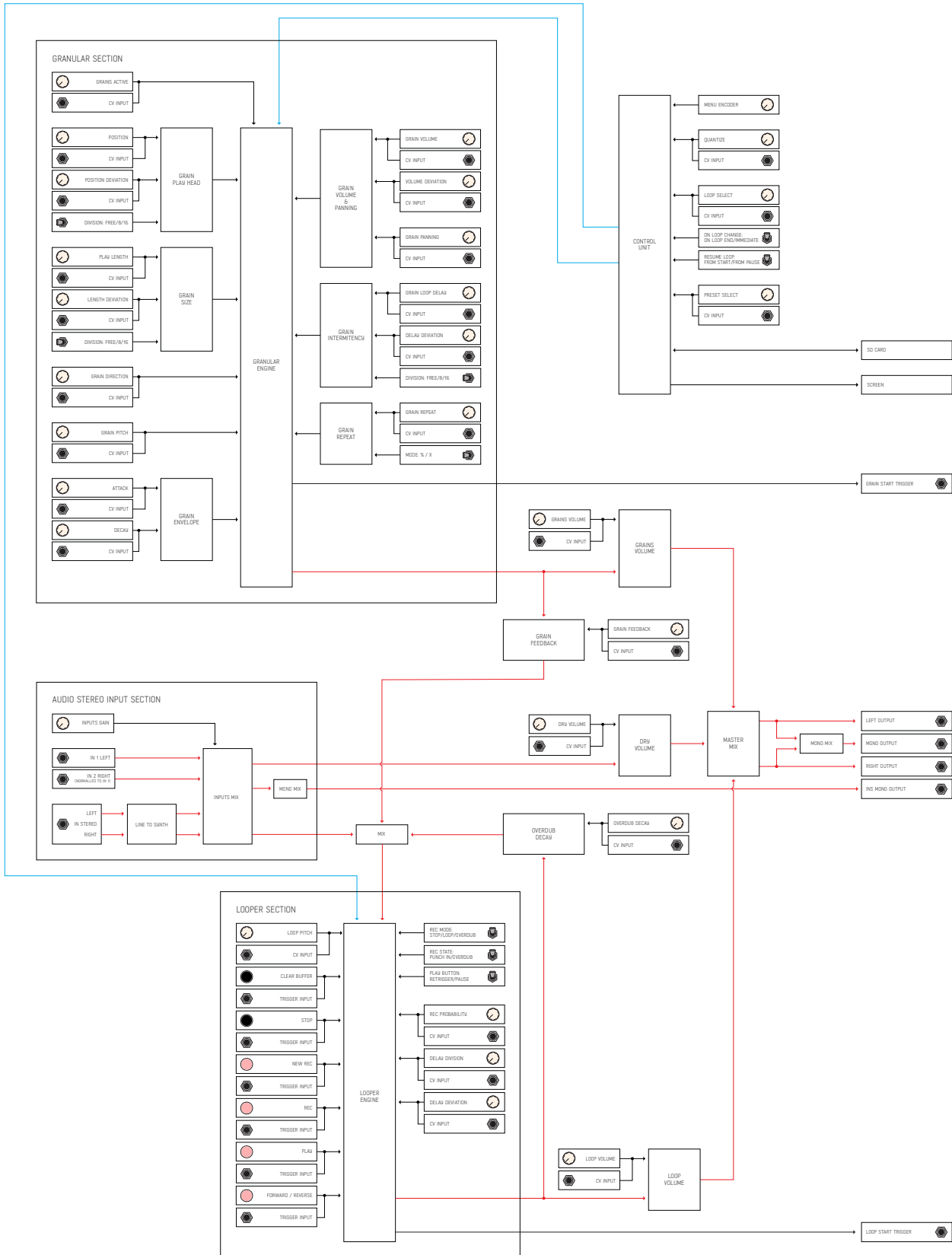

LOOPER ENGINE

The Looper section is where all Recording action happens.
 It can record up to 99 LOOPS per PRESET
 LOOPS are recorded in a list and selectable with the [LOOP SELECT] Knob or CV input
 The Looper playback volume is set using the [LOOP VOLUME] KNOB or CV input

SWITCHES SETTINGS:

[RETRIG. / PAUSE] determines how PLAY works while already playing the LOOP
 [RETRIG.] Pressing PLAY while retrigger the LOOP from the start
 [PAUSE] will toggle between Play and Pause states

[SYNC REC / UNSYNC] determines how the Recording Head works
 [SYNC REC] Rec Head follows the Play Head
 [UNSYNC] Independent Rec Head.

[REC MODE] : [OVERDUB / LOOP / STOP] determines what happens when finishes recording
 [LOOP] records continuously in a loop
 [PLAY] finishes recording and starts playback
 [STOP] finishes recording and stops playback
[STOP] mode will also stop playback at the end of the loop to allow "One Shot" loop playback

LOOPER PUSH-BUTTON CONTROLS:

[CLEAR] Clears the Entire LOOP buffer and resets the Recording and Playback heads to the start point. A long Press erases LOOP from list.

[STOP] Stops playback or recording

[REC NEW] Starts recording a new LOOP and adds it to the list.

[REC] Records on the current LOOP buffer.

[PLAY] Play / Pause / Retrigger the current LOOP

[FORWARD/REVERSE] determines the playback direction

For Ping-Pong mode simply patch the [LOOP TRIG.] output to [FORWARD/REVERSE] trigger input.

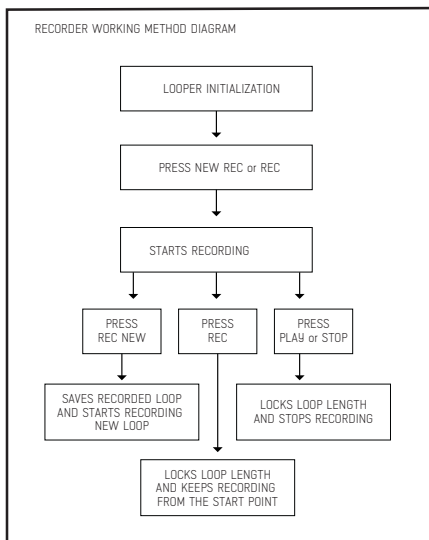
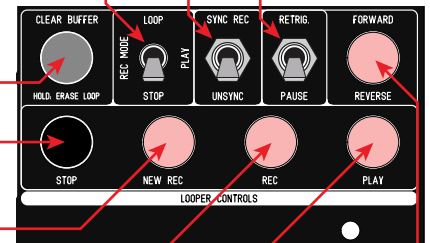

LOOPER ENGINE

LOOPER CONTROLS:

[LOOP VOLUME] sets the LOOP playback overall volume.

[LOOP SELECT] Determines which LOOP to play from the list in the current PRESET.

[LOOP PITCH] Determines the buffer playback rate setting the Pitch of the Loop from -2 to +3 octaves. The QUANTIZE Settings will influence this setting.

[OVERDUB DECAY] while recording determines the amount of the previous buffer content to be kept in the new buffer.

CONTINUOUS RECORDING SETTINGS:

Continuous recording is vital to apply a granular effect to an incoming audio source, adding some indeterminacy to the recording timing can create very interesting results we added two methods for this, Probability and Delay.

RECORDING PROBABILITY:

[REC PROBABILITY] Determines the probability that the recording will happen.

Recording is happening in a loop depending on the probability set here it will either record through the buffer or will REST and go through the buffer without recording at the end of the buffer it will calculate the new probability and record or rest for the next buffer period.

RANGE: 0 to 100%

RECORDING DELAY:

[DELAY DIVISION] Determines the amount of delay to pause for upon reaching the end of the buffer, meaning the continuous recording will pause at every recording loop for a multiple of 1/32 of the buffer length.

The DELAY led will light up while in this recording delay state

RANGE: 1 to 32

[DELAY DEVIATION] sets the amount of deviation from the [DELAY DIVISION] setting.

RANGE: 0 to 100%

REC/PLAY MODES & ON LOOP CHANGE SETTINGS:

These options are shared for REC/PLAY modes as well as to define what happens whenever a new LOOP is selected using the [LOOP SELECT] knob or CV input.

[IMMEDIATE / ON LOOP]

REC: Determines if whenever a Recording is enabled it will start recording immediately or when the Play head crosses the end of the loop point and start recording from the beginning of the loop.

ON LOOP CHANGE: Determines if the new selected LOOP plays immediately after being selected or if it waits for the current LOOP to reach the end point and then make the LOOP change.

[RESET / PAUSE]

PLAY: Determines if when PLAY is engaged the loop will start from it's current position or if it resets to it's start position.

ON LOOP CHANGE: Determines if the new selected LOOP plays back from it's start point or resumes at the previous paused point

If a LOOP is changed while Recording the [LOOP SELECT] control will be ignored.

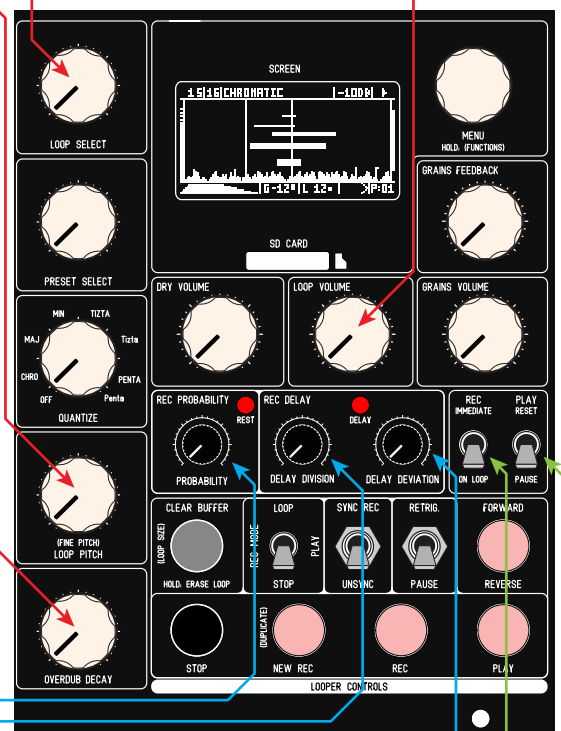

LOOPER ENGINE (PLAYBACK & RECORDING)

PLAYBACK & RECORDING

In earlier firmware revisions Loop Playback and Recording were exclusive, i.e. recording would stop playback.

Now Loop Playback, Grains Processing and Recording are independent and work in parallel. This allows to keep playing a loop granular process it while recording a new loop that, in turn, can also feed from these sources.

RECORDING INPUTS MIX:

At all times the signal that will be recorded is a mix of 3 sources with individual volume controls:

1. The Input audio volume is controlled by the [INPUT GAIN] pre-amp knob. The [DRY VOLUME] will also have control over the input gain if set to Post in the options menu.
2. The current Loop being played volume is controlled by the [OVERDUB DECAY] knob.
3. The Grains volume is controlled by the [GRAINS FEEDBACK] knob.

The sum of these 3 inputs will be sent to the recording head.

RECORDING:

There are mainly 3 different recording methods:

1. New Rec - Immediate (variable length)

Pressing [NEW REC] immediately starts recording a new loop with no defined end point, can be locked into a loop by pressing any of the four bottom buttons (Stop, New Rec, Rec or Play) each with it's different function.

2. New Rec - On Loop (fixed length)

Pressing [NEW REC] starts recording a new loop whenever the current loop playing crosses the start point (i.e. when it loops), the new loop being recorded will also stop recording whenever the current loop still playing crosses the start point once again. The length of the new loop recorded will then be the same as the previous loop.

If, while already recording, the switch is changed to immediate then the end point of the new loop becomes free and won't stop until one of the four bottom buttons is pressed.

If the switch is changed back to On Loop later on than it will again start tracking the current loop still playing and stop the recording at the end point of the loop. This can also be used to multiply the length of the current loop by an X amount of loops.

3. Overdub

Pressing [REC] will simply overdub the current loop, the 3 knobs controlling the recording inputs mix will determine what's being overdubbed.

[REC] button will also follow the settings from [REC MODE] and [Immediate/On Loop] switches

Every time the New Rec recording stops, it immediately changes the selected loop to the new loop.

Depending on the [REC MODE] switch when it stops recording will either enter Overdub, Playback or simply Stop the looper playback.

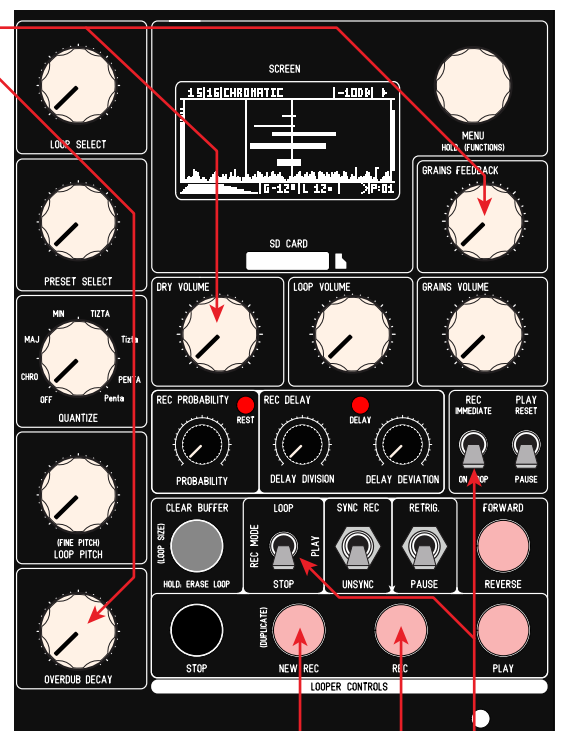

LOOPER ENGINE (SPECIAL FUNCTIONS)

DUPLICATE LOOP:

Loops can be duplicated by pushing and holding the [MENU] encoder button and then press [NEW REC].
The copied loop will appear at the last position in the loop index.
A message will appear stating: LOOP DUPLICATED

LOOP SIZE:

Using this shortcut will enter the Loop Editor, described further down in this guide.

CLOCKED MODE:

In Clocked Mode the Stop Button and respective trigger input will work as a Clock Input.
Clocked Mode changes the way the Looper Engine push buttons works. In this mode buttons [NEW REC] [REC] [PLAY] [FORWARD/REVERSE] (and their dedicated trigger inputs) instead of executing the actions immediately they will engage once activated (shown by blinking) and will only execute when the [STOP] button is pressed or a trigger on the Stop Trigger input is detected.
This way a clock input can be plugged in the Stop Trigger Input and all other Looper push buttons will be synced to the incoming clock, quantizing the timing of the user actions to the incoming clock.

NORMALIZE:

The loop volume can be normalized to -9db by pushing and holding the [MENU] encoder button and then press [REC].

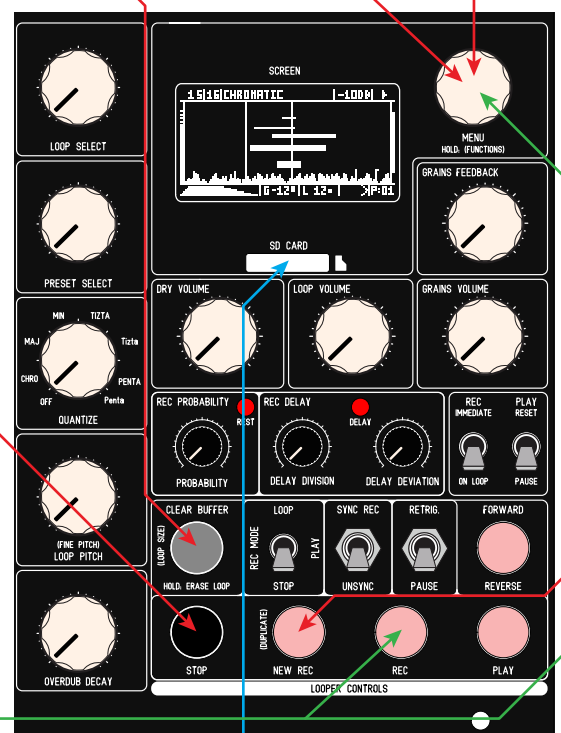

SD CARD

SD CARD:

Any SD Card can be used but we recommend "Class 10" SD Cards, these will save/load Banks faster. Cards above Class 10 won't have any significant impact on the save/load times. SD Cards should be formatted in FAT32 format.

If not saving or loading a Bank you can remove/insert an SD Card at any time.

LOOP EDITOR

The Loop Editor page allows to trim the current selected loop in different ways allowing flexibility and precision. All settings operate in real-time so besides precision editing it can also be used as a playable feature.

Scroll up and down with the encoder, click the encoder to edit the value, click once again to go back to parameter choice, hold the encoder to exit Loop Editor.

The low resolution loop wave representation, Start and End points can be seen at the bottom on the screen.

(New) When changing values a dynamic zoomed visualization will appear, focusing on the crossing point, the zoom factor is independent for each channel and continuously adjusts itself to fit the screen area.

TIME

Sets the total time of the loop in seconds

SAMPLES

Sets the total time of the loop in samples
(1 sample = 1/samplerate)

BPM

Sets the total time of the loop in BPMs

START

Sets the start position in samples

END

Sets the end position in samples

EDIT WITH POTS

This setting allows the user to use the Rec Delay knobs: [REC DIVISION], [REC DEVIATION] and respective CV inputs; as the start and end point controllers. Rec Delay and Start/End points knob and cv input controls are exclusive and they'll only work for one of the functions at any time.

When this setting is set to ON the Rec Delay feature will keep the settings defined at that moment, the knob controls will become inactive and not able to change the parameters until this setting is turned OFF. This option is a global option and also apply while outside the Loop Editor Page.

CONSOLIDATE LOOP

Updates the current loop to the selected loop region, deleting everything not between the Start and End points.

NEW LOOP FROM EDIT

Creates a new loop with the selected loop region and places it at the end of the loop index.

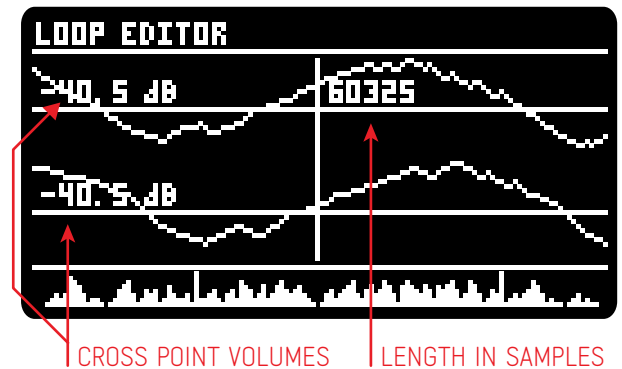

PITCH SHIFTING MODES

There are 5 different Pitch Modes available for the Looper Engine, these can be found in:
MENU > OPTIONS > LOOP PITCH MODE

1. Samplerate:

Uses a simpler sample rate change approach to change the pitch, in this mode the loop length is also affected by the pitch.

2. Pitch Shifting:

This mode only changes Pitch without changing the loop length

3. Time Stretching

This mode only changes the loop length without changing the pitch

4. Pitch/Time:

This mode changes both the Pitch and Loop length, similar to the Samplerate option but using the Pitch Shifting/-Time Stretching methods.

5. Pitch and Time:

This mode separately changes both the Pitch and Loop length.

When this mode is selected the [LOOP PITCH] controls the pitch and [REC DELAY DEV.] controls the time stretching. The Rec Delay Deviation function becomes inactive but the [REC DELAY] is still active.

All modes above except the Samplerate use a buffer to make it's operations, the user can also define the size of the buffer, diferent sizes have different algorithm "flavours", these can be found in:

MENU > OPTIONS > PITCH BUFFER SIZE

The Granular Engine can be set to the first 3 Modes although mode 2 and 3 will greatly reduce the maximum ammount of Grains Active possible.

GRANULAR ENGINE

Our Granular Engine features a deep set of controls to allow a wide range of results. It was designed to be fully hands-on and have all controls available in the front panel. Only minor settings were left in the menu alongside with Save/Load functions.

After the Grain is initialized (by adding a new grain or at startup) the engine will read and calculate all parameters. Once initiated grains play continuously calculating new settings every times it starts playing.

The Granular Engine feeds from whatever LOOP buffer is selected, hence the size of any grain is dependent of the LOOP size

GRAINS ACTIVE:

[GRAINS ACTIVE] Determines how many grains are being played at once
Range depends on the the SAMPLERATE and LOOP PITCH MODE options

GRAIN PLAY HEAD:

[POSITION] will determine the grain Start Point:
RANGE: 0-32

[SIZE DIVISION] : [FREE/8/16] will add a time quantization to the LOOP Buffer
[16] will divide the LOOP by 8 playing only from these start points
[8] will divide the LOOP by 4 playing only from these start points
[FREE] will apply no division

[POSITION DEVIATION] will determine the deviation to the Start Point:
RANGE: 0-100%

GRAIN SIZE:

[PLAY LENGTH] will determine the length of the grain:
RANGE: 0-100%

[SIZE DIVISION] : [FREE/8/16] will add a time quantization to the Length
[16] the length will always be multiples of 1/16v of the LOOP Length
[8] the length will always be multiples of 1/8 of the LOOP Length
[FREE] will apply no division

[LENGTH DEVIATION] will determine the deviation to the Play Length:
RANGE: 0-100%

GRAIN INTERMITENCY:

[GRAIN LOOP DELAY] will determine the length of the delay (wait in silence) after the grain finishes playing and before it plays again:

[SIZE DIVISION] : [FREE/8/16] will add a time quantization to the Delay
[16] the delay will always be multiples of 1/16 of the LOOP Length
[8] the delay will always be multiples of 1/8 of the LOOP Length
[FREE] will apply no division and set range from 0 to 5 seconds

[LENGTH DEVIATION] will determine the deviation to the Delay applied above:
RANGE: 0-100%

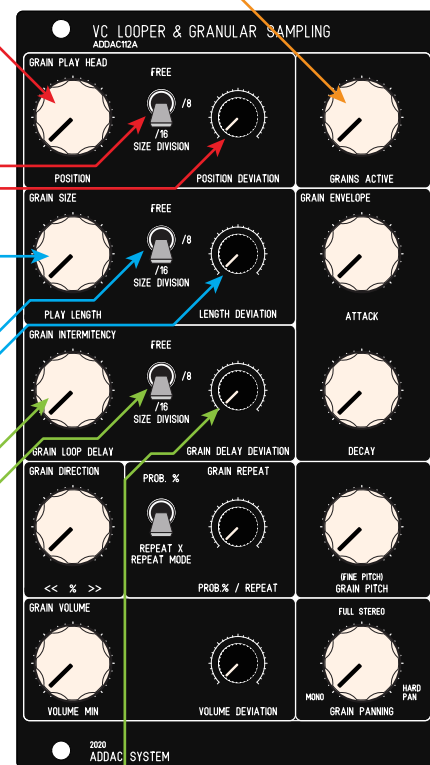

GRANULAR ENGINE

GRAIN DIRECTION:

[GRAIN DIRECTIONS] Sets the probability of the Grain Play Direction (Forward/Reverse)
 Full Left only plays in Reverse, Full Right only plays Forward

GRAIN REPEAT:

Grain Repeat will determine if the sample plays with the exactly same setting as the previously time played or if it calculates new parameters.
 There are 2 modes selected by the [REPEAT MODE] switch

[REPEAT MODE] : [PROBABILITY / REPEAT X] there are 2 Modes for this feature
 [PROBABILITY] sets the probability of repeat: 0 to 100%
 [REPEAT X] repeats the grain for X times: 0 to 16

[PROB.% / REPEAT] sets the value for the Mode selected.

GRAIN VOLUME:

[VOLUME MIN] sets the Minimum Volume for the grains

[VOLUME DEVIATION] sets the ammount of deviation from the Minimum Volume.

GRAIN PANNING:

[GRAIN PANNING] sets the Panning Probability based on the behaviour pictured below

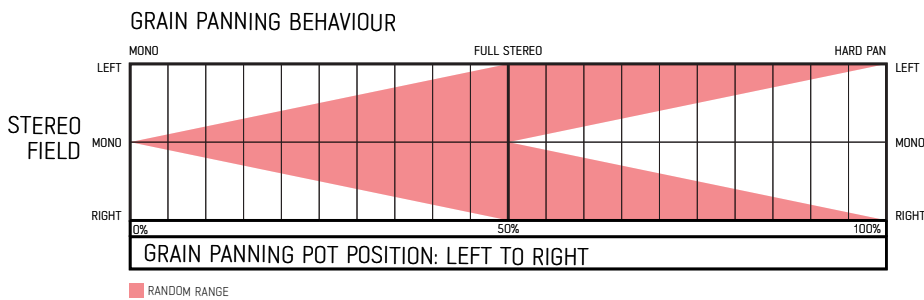

GRAIN PITCH:

[GRAIN PITCH] setting for the Grains Pitch: from -2 to +3 octaves

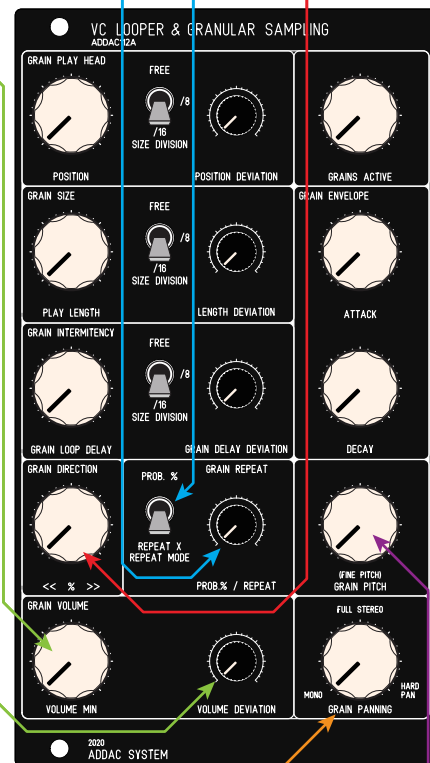

GRANULAR ENGINE

GRAIN ENVELOPE:

Envelope is applied throughout the full length of the grain to be played

[ATTACK] sets the Attack percentage

[DECAY] sets the Decay percentage

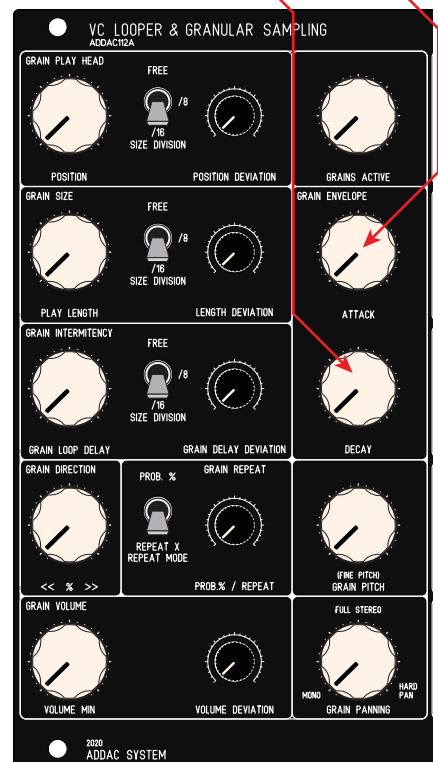
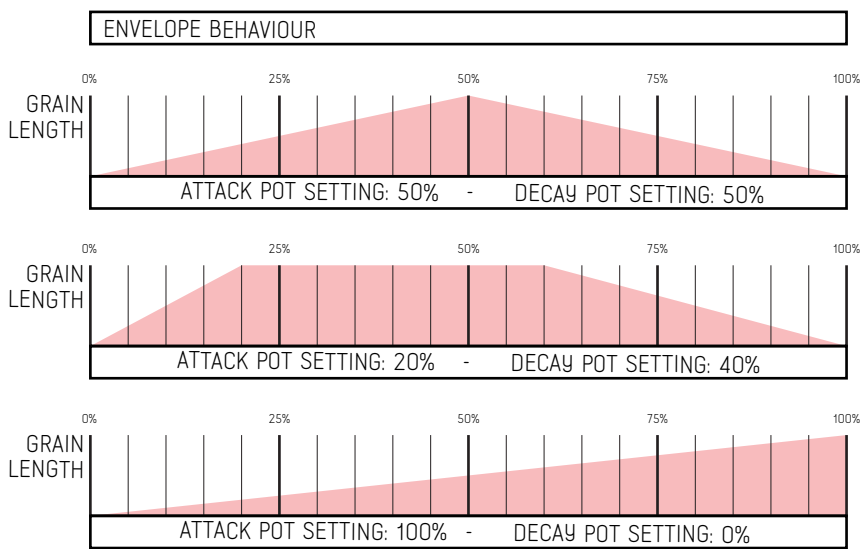

To summarize here's a diagram showing the working method:

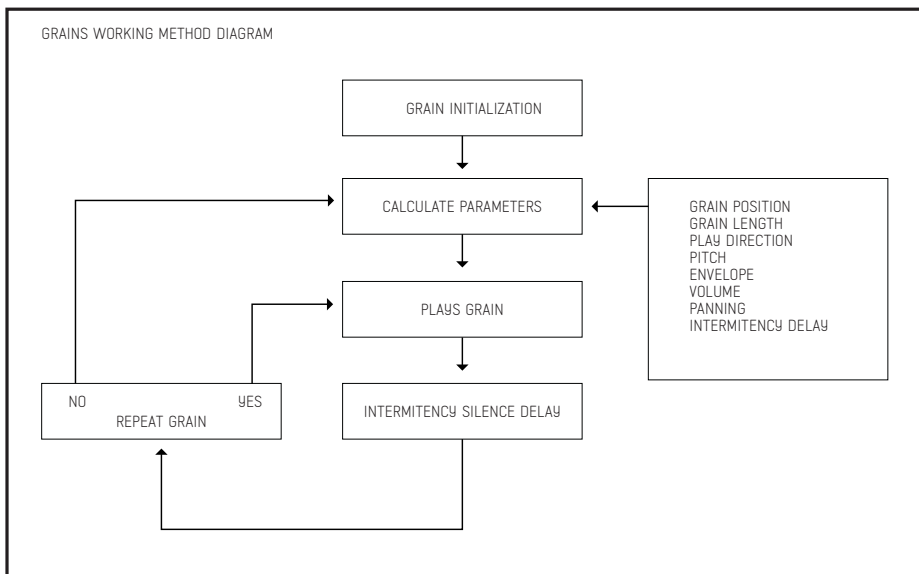

GRANULAR ENGINE

GRAIN PANNING MODES

There are 2 panning modes: Random and Travel, both share the same principle of panning distribution as shown in the graphic below

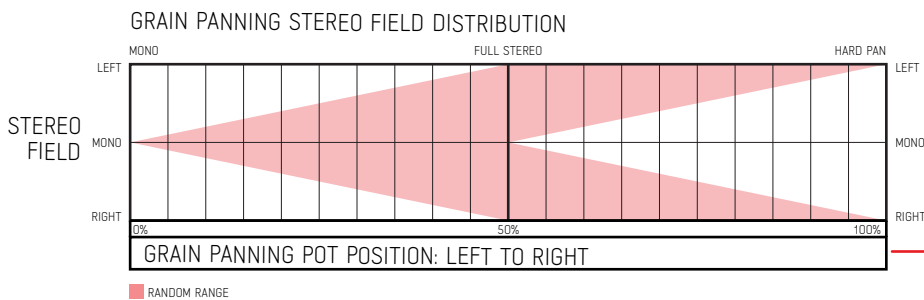

In both modes a new random value is generated at the start of the grain

- FIXED MODE

The grain will be positioned on the stereo field as indicated by the random value generated at the start and will remain static until the end of the grain. In other words the grains will always appear in a new random position.

- TRAVEL MODE

The grain will start wherever it was positioned at the end of the previous grain and, during it's length, it will travel on the stereo field towards the position indicated by the random value generated. In other words the grains will always be moving in the stereo field.

GRAIN TRIGGERING (New)

This feature allows to trigger grains into life using the [GRAINS N.] input. This input can differentiate between CV and Gate signals and will automatically adjust it's function to the input detected. When using a CV the input will respond normally and add/subtract grains according to the CV amplitude and the [GRAINS ACTIVE] knob position.

When using a Gate signal (10ms minimum) at every ON signal it will increase the grain count by 1 until the maximum grains count is reached. For this Gate detection to be effective the [GRAINS ACTIVE] knob must be below 1/4 of it's range, at it's leftmost point it will have no permanent grains and will trigger them according to the Gate detection, up to 1/4 of the knob range it will add some permanent grains and still add more according to the Gate detection. Beyond the 1/4 range the Gate signal will be interpreted as a CV input.

When these grains finish playing they will be erased and wait for more gate signals.

It can happen that when using random signals some fast CV amplitude changes will be interpreted as a Gate signal.

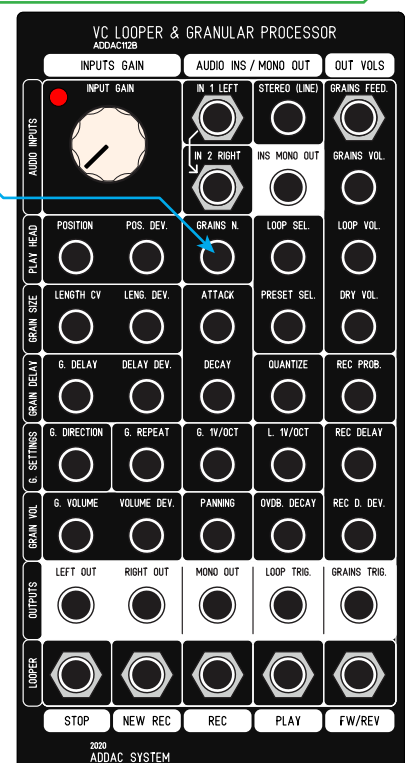
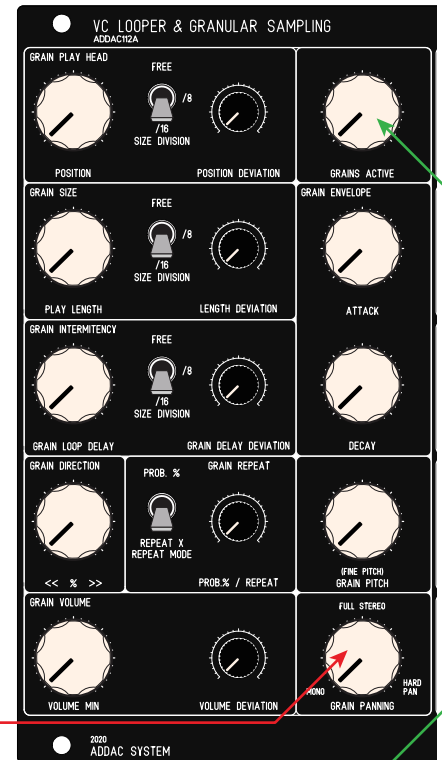

GRANULAR ENGINE (SPECIAL FUNCTION)

KILL ALL GRAINS:

By pushing and holding the [MENU] encoder button and then pressing [STOP] all grains will be instantly stopped.

A message will appear stating: ALL GRAINS STOPPED

This can be helpful to immediately stop long grains playing on long loops.

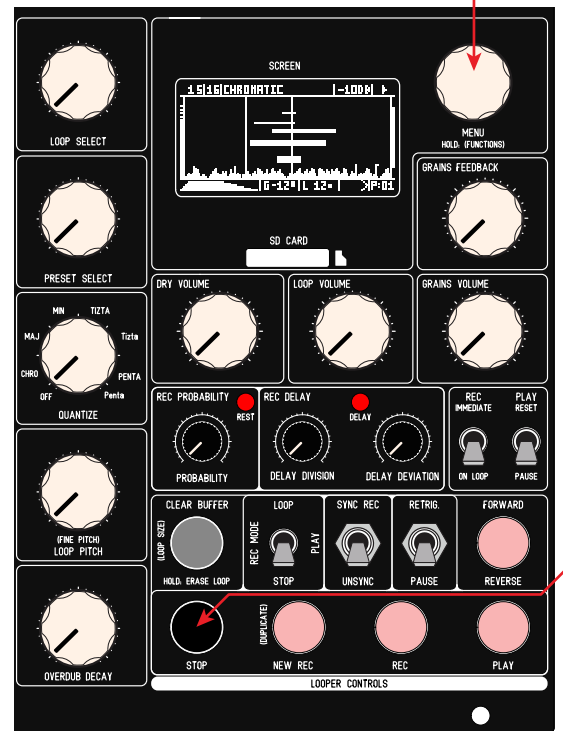

AUDIO INPUTS, OUTPUTS & FEEDBACK

INPUTS:

There are 2 input pairs on ADDAC112B:
 2 Mono inputs at Synth Level (IN 1 is normalised to In 2)
 1 Stereo input at Line Level

These inputs are mixed to a Stereo signal after which the [INPUT GAIN] knob sets the final gain sent to the Looper Engine.

An Led acts as a visual display for the level set. All inputs are also mixed down to a mono signal available at the [INS MONO OUT] jack

MAIN OUTPUTS MIX:

The Master Outputs sums the Looper and Granular Engine together with the Dry signal into a Stereo Output.

[DRY VOLUME] Sets the volume for the DRY Input into the Outputs.

[LOOP VOLUME] sets the volume for the LOOPER Engine into the Outputs.

[GRAINS VOLUME] sets the volume for the Granular Engine into the Outputs.

[GRAINS FEEDBACK] Sets the volume of the Granular Engine Mix sent into the Looper Audio Input

There are 3 physical outputs for the Main Mix:
 Left Output
 Right Output
 Mono Output (L+R)

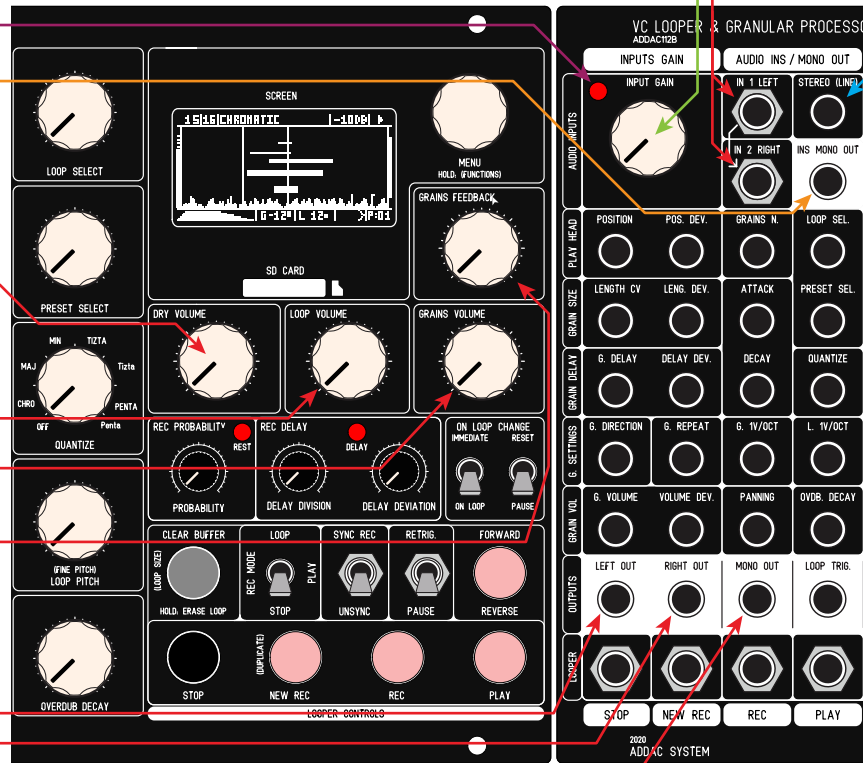

CV & TRIGGER INPUTS

All of the front panel Control Knobs have their own CV Input

All Controls on the left block can be found in the same matrix configuration on the Inputs Module

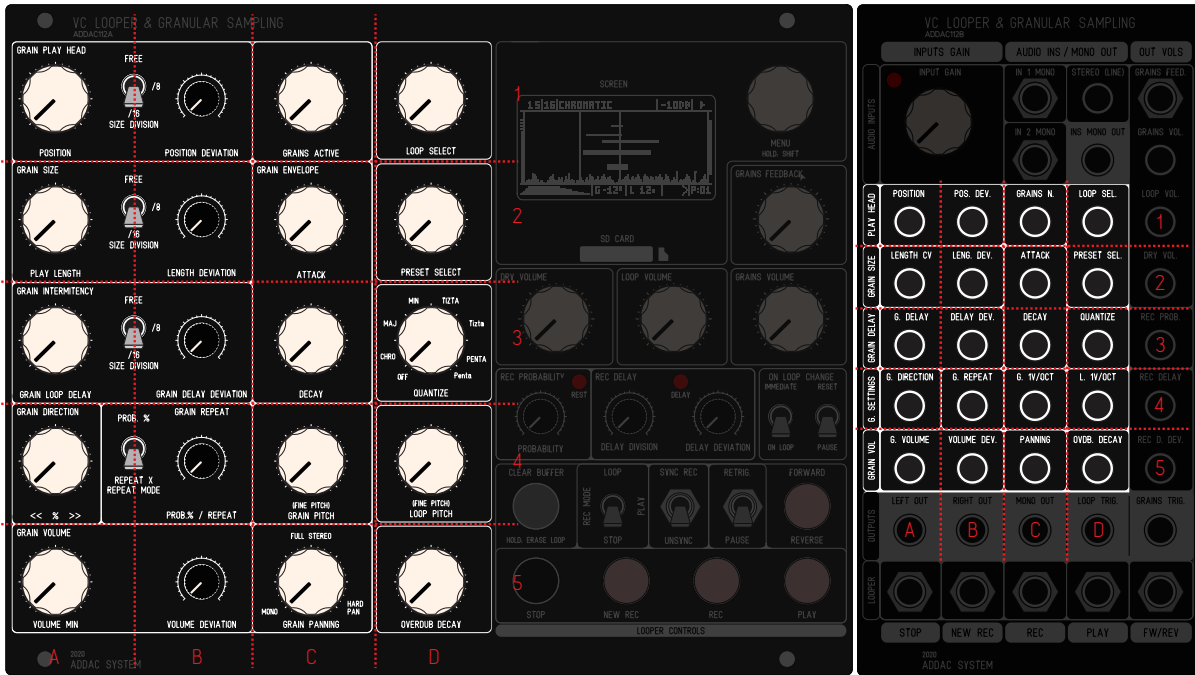

All Controls on the right block can be found vertically from the top right corner
 All Trigger inputs for the Looper controls can be found at the bottom of the module

The [CLEAR BUFFER] control is the only push button without a Trigger input.
 Encoder and Toggle switches have no CV inputs.



OLED MONITOR

MAIN SCREEN:

The Main Screen shows the most important info for overall operation.

LOOPER STATE

Shows REC / PLAY / PAUSE / STOP states

INPUT VOLUME MONITOR

A real-time input level monitoring in decibels, above -5db the colors will invert to represent clipping

QUANTIZATION SCALE

Scale selected

GRAINS ACTIVE

Number of active Grains

MONO/STEREO INDICATOR

S - Stereo file
M - Mono file

LOOP SELECTED

The current loop being played, inverted colors show up when using the On Loop feature, meaning it will show the loop it will jump to as soon as it crosses the current loop end point.

GRAINS VOLUME & DEVIATION

The white bar shows the [VOLUME MIN] setting
The traces on top shows the maximum random set by [VOLUME DEVIATION]

WAVEFORM REPRESENTATION

Low resolution representation of the waveform

ATTACK & DECAU

Grains envelope representation

GRAINS PITCH

The current grains pitch, the small rectangle at the end shows the cents difference from the perfect note

LOOP PITCH

The current loop pitch, the small rectangle at the end shows the cents difference from the perfect note

GRAIN DIRECTION

PRESET SELECTED

GRAINS PANNING

The vertical bar represents the stereo field, the white area(s) show the range of the randomization applied to the grains panning

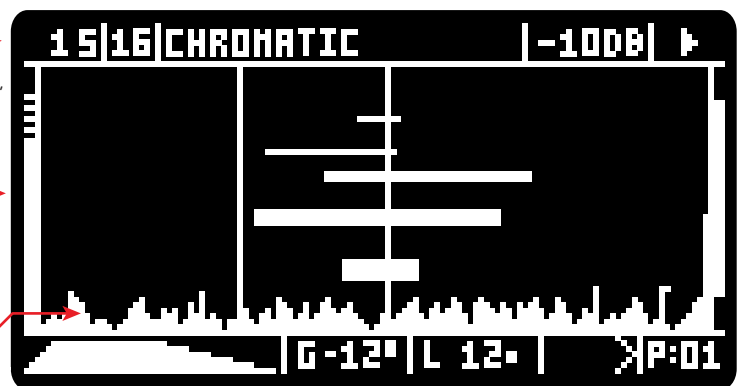

OLED MONITOR

PLAY HEAD

Shows the current position of the playback head

RECORDING HEAD

Shows the current position of the recording head

GRAINS LENGTH

Second vertical bar shows the setting defined by [LENGTH]

GRAINS POSITION

First vertical bar shows the setting defined by [POSITION]

GRAINS DISPLAY

Represents all active grains
 Length in the X axis
 Panning in the Y axis
 Volume in thickness

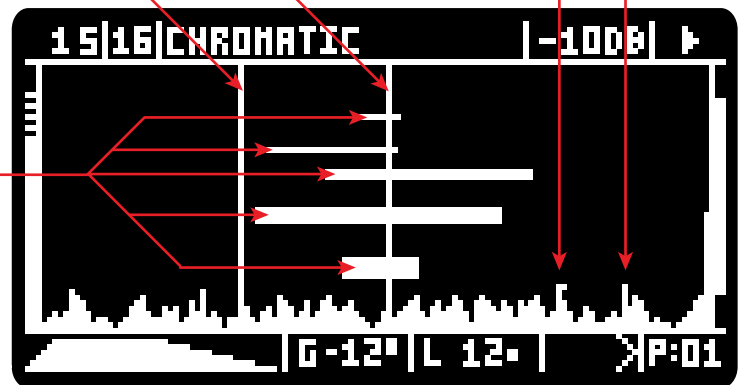

OLED MONITOR (SPECIAL FUNCTIONS)

SMALL DOT

Whenever this dot appears it means that the loop selected is either not saved in the SD Card or it has been changed since it was loaded from the SD Card



LOOP SELECTED WHITE AREA

This color inversion will be shown whenever the [On Loop] switch setting is engaged, where the user has already selected a new loop but it will only effectively jump to it once the current loop reaches it's end.



INPUT VOLUME MONITOR WHITE AREA

Whenever the input volume goes above -5db it will invert the colors to show it's close to clipping.



MAXIMUM ACTIVE GRAINS & CPU OVERLOAD

CPU overload will cause undesired audio glitches and drastically slow down the module's responsiveness. In this firmware revision we introduced a method that automatically reduces the number of active grains in order to keep the CPU at a safe level.

CPU WARNING:

In order to monitor the CPU state whenever the CPU goes above 90% a warning message appears on the top right corner

GRAINS ACTIVE VISUALIZATION:

The number in this area will always show the grains active setting set by the knob and cv input, although there will be times when, for example, if the user reduces the amount of grains, at these times while the number shown already reflects the control changes there will still be grains playing. When this happens the area colors will invert showing a white background and black number, going back to the regular color state once the grains setting matches the active grains playing. This also happens when are automatically reduced to avoid CPU stalling.

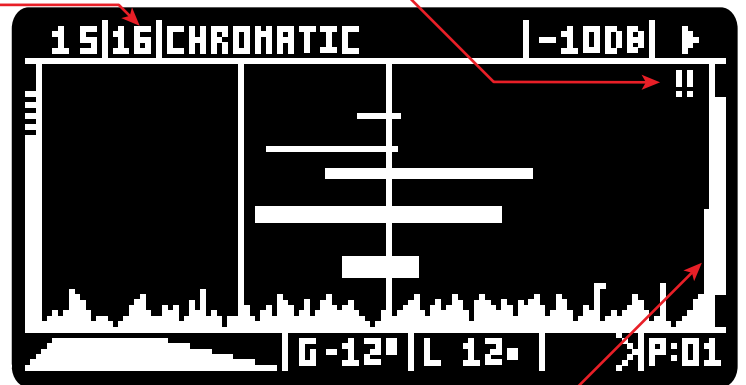

CPU USAGE:

The small bar rising vertically represents the CPU percentage in Y axis

INFO SCREENS

Rotating the [MENU] encoder at any point while on the main screen leads you into the info screens

INFO PAGE:

This will show the current configuration general settings:

Stereo or Mono Recording
 Sample Rate
 Bit Depth

Current Bank
 Number of Loops in current Bank
 Selected Loop duration in seconds
 Selected Loop duration in BPM
 Free Memory in seconds
 Master Out dB meter



CONTROLS 1 PAGE:

This will show the left side controls real-time values, includes Knob/CV values and switches state.

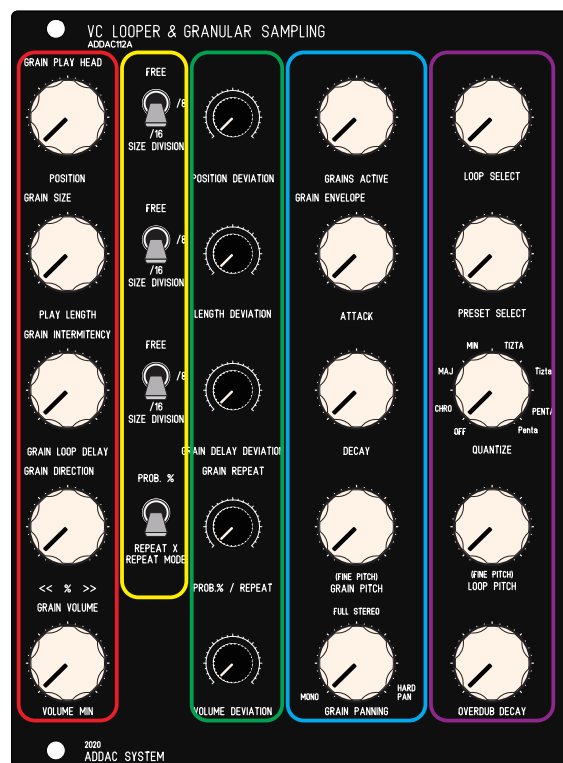
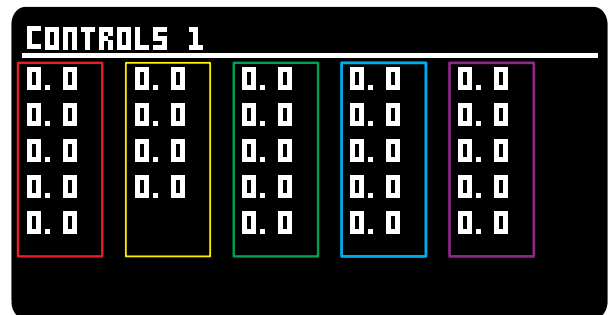

INFO SCREENS

CONTROLS 2 PAGE:

This will show the right side controls real-time values, includes Knob/CV values and switches state.

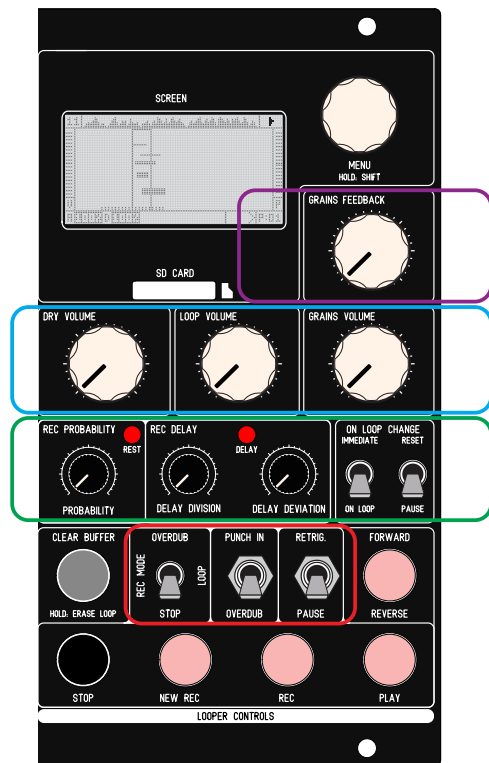

MAIN MENU

MENU

Pressing the [MENU] button shows the main menu window:
A long press of the [MENU] button exits whichever Menu without making changes

1. PRESET:

- NEW - Adds a new preset to the Presets list with the current settings
- UPDATE - Updates the current preset to the current settings
- ADD LOOPS - Presets also store a selective list of loops, this updates the current preset loop list to all loops available in memory
- DELETE - Permanently deletes the current Preset

2. BANK:

- NEW - Creates a new empty Bank with 2 choices
 - CURRENT CONFIG: Uses all current BANK settings
 - DEFAULT CONFIG: Uses default BANK settings
- LOAD - Loads a Bank from the SD Card
- SAVE - Saves a bank to the SD Card
- SAVE IN NEW - Saves the current bank to a newly named bank, the new bank name will be the next available number (example =8) followed by the current bank name (example = 3) BANK8>FROM3

3. LOOP EDITOR:

Enters Loop Editor page.

4. OPTIONS:

Enters Options page.

5. SIDECHAIN COMPRESSOR (SCC): (New)

SCC routes the dry input through an envelope follower and uses that signal to compress the loop and grains volumes.

STATE:

- OFF (default): No compression applied
- LOOP: Applies compression to the Loop Volume
- GRAINS: Applies compression to the Grains Volume
- BOTH: Applies compression to Both

ATTACK: Sets the Attack time in seconds

RELEASE: Sets the Release time in seconds

RATIO: Sets the Ratio factor

THRESHOLD: Sets the threshold level in dB

MAKEUP GAIN: Sets the makeup gain in dB

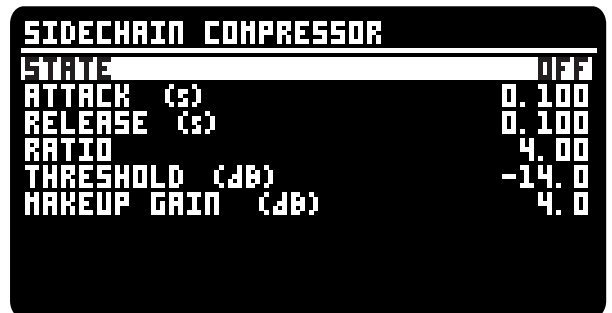
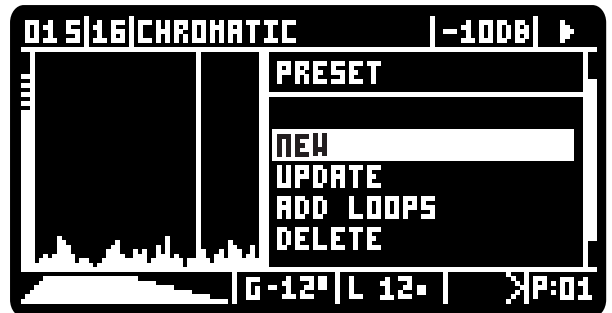

OPTIONS MENU

OPTIONS SUBMENU PAGE 1 - REC SETTINGS

MONO/STEREO:

Sets the Looper Engine for Mono or Stereo Recording

SAMPLERATE:

The heart of the module: global samplerate setting:

8Khz, 11khz, 16Khz, 22khz, 32Khz, 44.1khz, 48khz, 96khz

BIT DEPTH:

The bit depth resolution:

24 bit: In this setting the sampling memory is reduced by 50%

16 Bit

8 Bit

ANTI-ALIASING:

Use Anti-Aliasing On for a modern pitch shifting interpolated algorithm, Off for an old school flavour without interpolation.



OPTIONS SUBMENU PAGE 2 - REC OPTIONS

OVERDUB ORIGIN:

PLAY HEAD - Overdub comes from the Play Head position

REC HEAD - Overdub comes from the Rec Head position

BOTH - Overdub comes from the Both Heads positions

RESAMPLING PITCH:

FIXED AT ZERO - Recording at the PAGE1:SAMPLERATE setting

FOLLOWS LOOP- Recording samplerate varies according to the playback pitch

REC DIRECTION:

DISABLED - Rec Head always goes forward and ignores [FORWARD/REVERSE] button

ENABLED - Rec Head follows [FORWARD/REVERSE] button

DRY VOLUME PRE/POST:

PRE - AUDIO INPUT volume only depends on the [INPUT GAIN] knob

POST - AUDIO INPUT volume depends on both the [INPUT GAIN] and [DRY VOLUME] knobs.

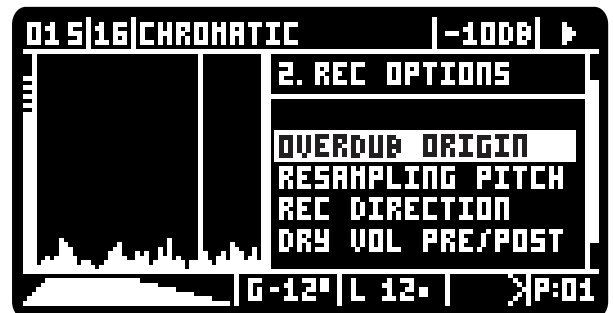

OPTIONS MENU

OPTIONS SUBMENU PAGE 3 - PITCH OPTIONS

LOOP PITCH MODE:

- SAMPLERATE- Pitch shifting using sample rate change
- PITCH SHIFTING - Changes pitch without changing the loop length
- TIME STRETCHING - Changes the loop length without changing pitch
- PITCH/TIME - Changes Pitch and Length as in SAMPLERATE
- PITCH AND TIME - Independent control of loop Pitch and Length

GRAIN PITCH MODE:

1. SAMPLERATE- Pitch shifting using sample rate change
 2. PITCH SHIFTING - Changes pitch without changing the original length
 3. TIME STRETCHING - Changes the length without changing the
- *WARNING:** Mode 2 & 3 reduce the total ammount of grains possible

PITCH BUFFER SIZE:

Pitch shifting and Time stretching use a buffer to make it's operations, here you can define the size of the buffer, diferent sizes have different algorithm "flavours".

PITCH RANGE:

Pitch ranges can vary to have more pitch control over smaller ranges. **1v/oct is only respected on the first option!**

1. -24 +36 : -2 to +3 octaves
2. -12 +12 : -1 to +1 octaves
3. -2 +2 : -2 to +2 semitones
4. -INF +24 : from stop to +2 octaves*

[QUANTIZE] needs to be set to Off for mode 2, 3, 4 to engage

***WARNING:** In this mode the user needs to pay attention to the Grains pitch, if set to -INF the grains will play at zero speed and will stall the grains engine. To recover from this set the menu option: GRAINS PITCH to: CHANGE.

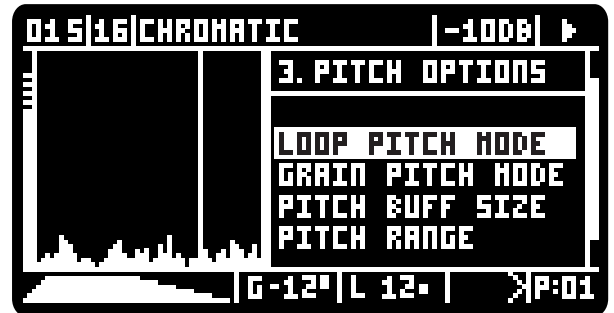

OPTIONS SUBMENU PAGE 4 - QUANTIZE OPTIONS

PITCH (ZERO) NOTCH:

If quantization is not engaged it can be hard to set the loop pitch for perfect zero, engaging this function creates a small notch area where it locks the pitch to perfect zero.

A pixel lights up on the screen when perfect zero pitch is set.

QUANTIZER:

- BOTH - Applies quantization to both the Looper and the Grains Engines
- LOOPS ONLY - Only applies quantization to the Looper Engine
- GRAINS ONLY - Only applies quantization to the Grains Engine

SCALES SET:

- DEFAULT - Default quantization scales
- CUSTOM - custom quantization scales



OPTIONS MENU

OPTIONS SUBMENU PAGE 5 - GRAINS OPTIONS

GRAIN DEVIATION MODE:

RANDOM / SPREAD - Changes the Deviation working method as previously described in pages 7 through 9.

GRAIN PAN MODE:

FIXED / TRAVEL - Changes the Panning working method as previously described in page 18.

GRAINS PITCH:

When either the [GRAIN PITCH] knob is moved or a new CV is detected the grains pitch can be set to:

KEEP - each grain keeps the initial pitch until the end of it's length

CHANGE - immediatelly changes the pitch of all grains at once



MAX GRAIN DELAY:

Sets the maximum time for the Grain Intermitency:

LOOP - Maximum time equals loop size

5 SEC - Maximum of 5 seconds

30 SEC - Maximum of 30 seconds

GRAIN SAMPLERATE:

Sets the Grain Samplerate, this will reduce the impact of the grain engine on the CPU and allow more grains to be used.

FULL - Same as global Samplerate

HALF - Half of global Samplerate

QUARTER - Quarter of global Samplerate

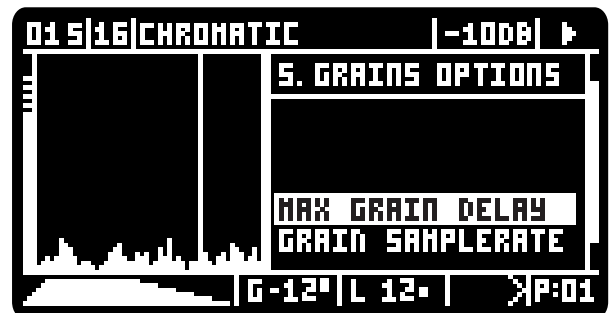

OPTIONS SUBMENU PAGE 6 - SPECIAL MODE

CLOCKED MODE:

Clocked Mode is one of the Looper Special Functions described in page 14, to activate select ON.

PITCH DIRECTION CONTROL:

A special mode that allows the loop pitch control to also control the looper playback direction somewhat resembling controlling a turntable. From 0v to +2.5v it will play in reverse while pitching down to an almost stop, from +2.5v to +5v will play forward pitching up to the pitch chosen by the range selected: Narrow or Wide.

OFF - disabled

NARROW - At both ends pitch will be at zero

WIDE - At both ends pitch will be +12 semitones

In this mode the [FORWARD/REVERSE] button is not active instead it monitors the playback direction.

Also there is no 1v/octave in this mode.



OPTIONS MENU

OPTIONS SUBMENU PAGE 7 - OTHER OPTIONS

SPECIAL FUNCTIONS:

Here special functions can be activated/deactivated so that they won't be mistakenly activated when using external inputs for the same buttons while operating the encoder.

KILL ALL GRAINS - On/Off - [STOP] button

DUPLICATE - On/Off - [NEW REC] button

NORMALIZE - On/Off - [REC] button

PAUSE MODE:

TOGGLE - toggles between pause and play

MOMENTARY - pauses while button is pressed or GATE Input is On

TRIGGER SIZE:

The length of both trigger outputs in milliseconds

1 MS

10 MS

VOL IN PRESETS:

Applies to whether the Volume controls will be loaded from Presets at every Preset change or if the Preset value is ignored and only keeps track of the volume control knobs. Yes for loading the preset value, No to ignore the preset value. Default value is NO.

DRY: YES/NO - Dry volume

LOOP: YES/NO - Loop volume

GRAINS: YES/NO - Grains volume

OVERDUB: YES/NO - Overdub Decay volume

FEEDBACK: YES/NO - Grains Feedback volume

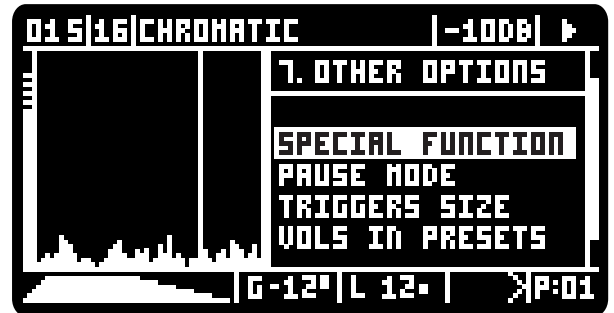

OPTIONS SUBMENU PAGE 8 - BOOTLOADER

UPDATE BOOTLOADER:

Pressing this option will suspend the module operation and enter DFU mode waiting for the new bootloader to be uploaded.

Follow the instructions in the Firmware Update section of this guide for more detailed information.

INFO:

Show Hardware and Firmware versions

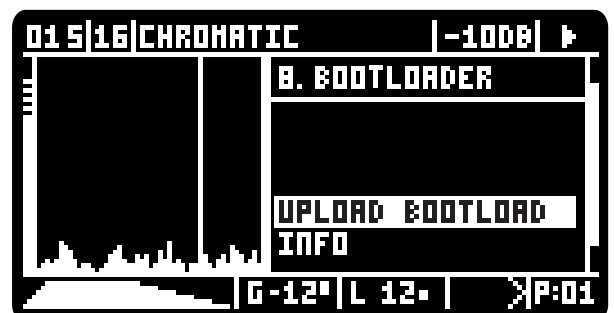

QUANTIZATION

QUANTIZATION

There are 7 scales slots and a fixed OFF Position.
The 7 Slots can be customized to any ratio by the user.

Inside MENU > OPTIONS > SCALES SET the user can choose between DEFAULT and CUSTOM scales:
DEFAULT are the default scales written on the front panel
CUSTOM are user customized scales

We decided to leave both of these scales open to customization to an overall number of 14 scales.

QUANTIZATION SCALES FILE:

Every BANK folder has a SCALES.CFG file, this file contains all scales ratios and can be edited in a simple text editor.
For anyone not used to programming this file will look a bit cryptic and remember it is important to keep it tidy with all the brackets, commas and other punctuation elements in their correct place.

FILE STRUCTURE:

This is the file structure, you can see that there are repeated blocks for each of the slots, the user should only edit the ratios list and the name inside the quotation marks, for example the chromatic scale name:

"name": "chromatic",
would be changed to:
"name": "my custom scale",

Make sure to keep all commas in their place!

Scales are not limited to 12 notes per octave, the user can add as many ratios as notes wanted.

SCALE MODES:

There's a final setting at the end of each scale ratios titled "per_octave", this setting can only be set to true or false:

"per_octave": true
used for any set of ratios to be repeated across octaves, so every ratio is present in every octave.

"per_octave": false
used for any scale that does not respect octaves, ratios will not be repeated. There will be as much notes as ratios included.
for example this is the Harmonic Series setting:

```
"name": "harmonic",
"ratios": [
1.
2.
3.
4.
5.
6.
7.
8.
9.
10.
11.
12.
13.
14.
15.
16.
],
"per_octave": false
```

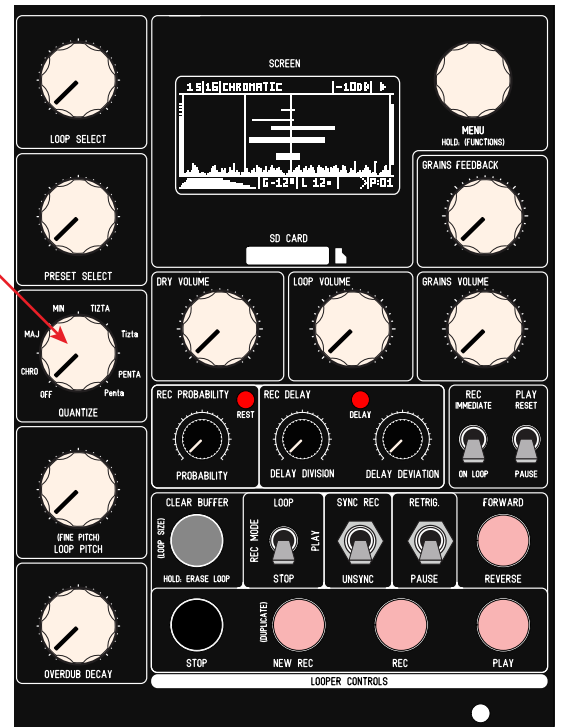

```
{
  "Default Scales": [
    {
      "name": "chromatic",
      "ratios": [
        1,
        1.059460044,
        1.122460008,
        1.189210057,
        1.259920001,
        1.334830046,
        1.414209962,
        1.49830997,
        1.58739996,
        1.681789994,
        1.781800032,
        1.88775003
      ],
      "per_octave": true
    },
    {
      "name": "major",
      "ratios": [
        1,
        1.122460008,
        1.259920001,
        1.334830046,
        1.49830997,
        1.681789994,
        1.88775003
      ],
      "per_octave": true
    }
  ],
  (A LOT MORE HERE)
}
```

QUANTIZATION

ROOT SCALES FILE

You will also find a SCALES.CFG file on the root of the SD Card, this is the default template that is used when creating a New Bank with Default Configuration. This is the file to edit and add all your favorite scales. Making it easier for the user to have all his scales at every New Bank without the need to edit it every time.

After the New Bank is created a copy of the SCALES.CFG will be stored inside the BANK folder.

Remember you can customize both the 7 Standard and the 7 Custom scales, to a total of 14 scales.

When creating a New Bank with Current Settings the Scales file comes from the current bank folder instead of the root file.

FIRST STEPS

First let's create a new empty BANK

Press the Menu Encoder and the Menu will appear on the screen, select BANK then select NEW

We now have a new empty Bank in volatile memory

Everything done from now on will not be saved if you turn the module off, when you're happy or ready to power down open the Menu, select BANK and then SAVE, this will save all the contents of the BANK to the SD CARD and will be loaded upon startup.

Set the [INPUT GAIN] until you see some LED activity and bring the [DRY VOLUME] knob up to hear the incoming audio

Next let's record our first loop.

Notice the Loop index displays "-" = No Loops

Press [NEW REC] or [REC] when you're happy with the length of the loop press one of the following:

[REC] enters Overdub Mode

[PLAY] Stops recording and enters Playback Mode

[STOP] Stops recording and playback



Now the Loop index will display "1"



Let's record a second loop.

Press [NEW REC] followed by [PLAY] when you're happy with the length of the loop, this will stop recording and start Playback.

Notice the Loop index will display "2"

Bring the [LOOP VOLUME] knob up to hear the loop playback

To be less confusing bring the [DRY VOLUME] knob down to hear only the loop playback

Now you can use the [LOOP SELECT] knob to switch between loop 1 and 2

You can also use the [LOOP PITCH] knob to adjust the playback samplerate

Now let's process the loop playing through the granular engine.

Bring the [GRAINS VOLUME] knob up to hear the grains playback and use the control knobs as defined before to get to an overall setting that you're happy with



Now let's create a Preset.

Notice the PRESET index displays "-" = No Presets

Press the [MENU] encoder, select PRESETS and then select NEW

This will generate Preset number 0 (zero)



Now let's create a second Preset.

Use the control knobs once again to change the granular settings and then press the [MENU] encoder, select PRESETS and then select NEW

This will generate Preset number 1



Now you can use the [PRESET SELECT] knob to switch between preset 0 and 1

Next let's save this Bank with all its loops and presets.

press the [MENU] encoder, select BANK and then select SAVE, audio playback will stop at this point and will resume as soon as it finishes saving all the data to the SD CARD. Once all data is saved a message will appear on the screen.

You can now switch off the module all the data is safe.

For convenience the last Bank saved will be automatically loaded on startup.

BOOTLOADER & FIRMWARE UPDATES

From V1.5 on, ADDAC112 uses a bootloader.

The bootloader will allow us to have more program space for future improvements.

It needs to be loaded into the ADDAC112 only the first time. After the bootloader is programmed, all firmware updates are made using the SD card.

You'll find 2 files on our website:

ADDAC112_Bootloader.bin - updated via web programmer

ADDAC112_Granular_Vxxx.bin - updated via sd card

BOOTLOADER PROGRAMMING INSTRUCTIONS

To update the bootloader you need to detach the 112A from your frame but leave the ribbon power cable connected and the Power ON. Once lifted from the frame locate the Micro USB input between the two pcbs on the right side of the module. Plug a cable to it and to your computer.

Before starting the process make sure your cable is a proper standard USB cable.

Some cables look just like a USB cable but they are used to charge/power other devices and do not have the necessary USB transmission lines.

1. Download and unzip this .hex file:

https://media.addacsystem.com/firmwares/ADDAC112_firmware.zip

2. On the module press encoder > Options > Update Firmware

3. Using the **Chrome browser** go here:

(You will need an up-to-date version of Chrome, at least version 61 or newer)

<https://electro-smith.github.io/Programmer/>

4. Press the "Connect" button and, from the options, choose the one called "DFU in FS Mode - paired" (ignore platform and example drop menus)

5. Press "Choose file" and choose the downloaded "ADDAC112_Bootloader.bin" file.

6. Press "Program" and it will show some progress bars on the browser, wait until done.

7. Once finished disconnect the USB cable

The module is now ready to receive the new ADDAC112 firmware.

FIRMWARE UPDATE INSTRUCTIONS

1. Copy "granular_Vxxx.bin" to the root of a micro SD card (FAT32)

2. Insert the SD card in the SD card slot in ADDAC112

3. Power off

4. Power on

---- DO NOT REMOVE THE SD CARD OR POWER OFF DURING THE NEXT STEP ----

5. The screen will show the uploading progress:

"Uploading firmware..."

"23%
"

6. When finished, the main screen should appear. The update was successful.

7. Power Off

8. Power On and you're all set!

GLOBAL.CFG FILE STRUCTURE

At the Root of the SD Card any there's a GLOBAL.CFG file, this file stores the last BANK saved and will automatically load it when the module is powered up.

GLOBAL.CFG
bank-2

Description:
> Last BANK saved

SETTINGS.CFG FILE STRUCTURE

Inside any BANK folder there's a SETTINGS.CFG file, this file stores all overall bank settings as described below. These files can also be edited by the user on a computer in a simple text editor, for users not used to programming this file will look a bit cryptic but remember it is important to keep it tidy with all the brackets, commas and other punctuation elements in their correct place. make sure only to change the values and everything else is kept with the same way.

These settings will always be active when preset "-" is selected.

SETTINGS.CFG
dry_vol_pre_post=0
quant_mode=0
pause_mode=0
overdub_origin=0
scales_set=0
keep_grain_pitch=1
samplerate=44100
resampling_pitch=1
pitch_range_octaves=2.500
clocked_mode=0
trigger_size_ms=10
stereo=1
bit_depth=2
rec_dir_en=0
anti_alias=1
grain_dev_mode=1
grain_pan_mode=0
vols_in_presets=255

Description:

- > Dry Volume Pre/Post: 0(pre), 1(post)
- > Quantization Mode: 0 to 7
- > Pause Mode: 0(toggle) or 1(momentary)
- > Overdub Origin: 0(playback head) or 1(recording head)
- > Scales Mode: 0(default) or 1(custom)
- > Grains Pitch: 0(change) or 1(keep)
- > Sample Rate: 8k to 96k (editing not recommended)
- > Resampling Pitch: 0(fixed at zero) or 1(follows loop)
- > Pitch Range: editing not recommended
- > Clocked Mode: 0(off) or 1(on)
- > Trigger Size: 1 or 10
- > Mono/Stereo: 0(mono) or 1(stereo)
- > Bit Depth: 0(24 bit), 1(8 bit) or 2(16 bit)
- > Rec Direction: 0(disabled) or 1(enabled)
- > Anti-Aliasing: 0(off) or 1(on)
- > Grain Deviation: 0(random) or 1(spread)
- > Grain Pan Mode: 0(fixed) or 1(travel)
- > Volume Controlled by Presets: editing not recommended

PRESETS FILE STRUCTURE 1/2

Inside any BANK folder and only if PRESETS were created and saved there will be a number of files named with a number and a ".CFG" termination, these files store all presets settings as described below. Once again, these files can also be edited by the user on a computer in a simple text editor, for users not used to programming this file will look a bit cryptic but remember it is important to keep it tidy with all the brackets, commas and other punctuation elements in their correct place. make sure only to change the values and everything else is kept with the same way. Users can also change the files names to reorder the presets.

0.CFG	Description:
pos=0.049	> Grains Position: 0.0 to 1.0
pos_quant=0	> Grains Play Head Size Division: 0(free), 1(/8) or 2(/4)
pos_dev=0.199	> Grains Position Deviation: 0.0 to 1.0
length=8969	> Grains Play Length: 0.0 to 1.0
length_quant=0	> Grains Size Division: 0(free), 1(/8) or 2(/4)
length_dev=0.999	> Grains Length Deviation: 0.0 to 1.0
delay=0	> Grains Delay: 0.0 to 1.0
delay_quant=8	> Grains Delay Division: 0(free), 1(/8) or 2(/4)
delay_dev=0.000	> Grains Delay Deviation: 0.0 to 1.0
direction=0.733	> Grains Direction: 0.0 to 1.0
repeat_mode=1	> Grains Repeat Mode: 0(repeat x) or 2(prob.%)
repeats=0.000	> Grains Repeat: 0.0 to 1.0
vol_min=0.93	> Grains Volume Min: 0.0 to 1.0
vol_dev=0.787	> Grains Volume Deviation: 0.0 to 1.0
n_grains=9	> Grains Active: (edit not recommended)
attack=0.190	> Grains Attack: 0.0 to 1.0
decay=0.775	> Grains Decay: 0.0 to 1.0
grain_pitch=1.000	> Grains Pitch: (edit not recommended)
grain_pan=0.380	> Grains Panning: 0.0 to 1.0
feedback=0.000	> Grains Feedback: 0.0 to 1.0
selected_loop=0	> Selected Loop: (edit not recommended)
quantizer=7	> Quantizer: 0 to 7
loop_pitch=0.999	> Loop Pitch: (edit not recommended)
overdub_decay=1.000	> Overdub Decay: 0.0 to 1.0
vol_in=0.606	> Dry Volume: 0.0 to 1.0
vol_loop=0.818	> Loop Volume: 0.0 to 1.0
vol_grains=0.000	> Grains Volume: 0.0 to 1.0
rec_prob=1.000	> Rec Probability: 0.0 to 1.0
rec_delay=0.000	> Rec Delay: 0.0 to 1.0
rec_delay_dev=0.000	> Rec Delay Deviation: 0.0 to 1.0
rec_mode=0	> Rec Mode: 0(loop), 1(play) or 2(stop)
rec_sync=1	> Rec Delay: 0(unsync) or 1(sync rec)
pause_retrigger=0	> Play Mode: 0(retrigger) or 1(pause)
on_loop_change_mode=0	> Rec Switch: 0(immediate) or 1(on loop)
loop_play_mode=0	> Play Switch: 0(reset) or 1(pause)
loop_direction=1	> Play Direction: 0(reverse) or 1(forward)

Continues in the next page

PRESETS FILE STRUCTURE 2/2

The last items on the preset file are the same as in the SETTINGS.cfg file, the preset settings override the Settings.cfg configuration.

0.CFG	Description:
dry_vol_pre_post=0	> Dry Volume Pre/Post: 0(pre), 1(post)
quant_mode=0	> Quantization Mode: 0 to 7
pause_mode=0	> Pause Mode: 0(toggle) or 1(momentary)
overdub_origin=0	> Overdub Origin: 0(playback head) or 1(recording head)
scales_set=0	> Scales Mode: 0(default) or 1(custom)
keep_grain_pitch=1	> Grains Pitch: 0(change) or 1(keep)
samplerate=44100	> Sample Rate: 8k to 96k (editing not recommended)
resampling_pitch=1	> Resampling Pitch: 0(fixed at zero) or 1(follows loop)
pitch_range_octaves=2.500	> Pitch Range: editing not recommended
clocked_mode=0	> Clocked Mode: 0(off) or 1(on)
trigger_size_ms=10	> Trigger Size: 1 or 10
stereo=1	> Mono/Stereo: 0(mono) or 1(stereo)
bit_depth=2	> Bit Depth: 0(24 bit), 1(8 bit) or 2(16 bit)
rec_dir_en=0	> Rec Direction: 0(disabled) or 1(enabled)
anti_alias=1	> Anti-Aliasing: 0(off) or 1(on)
grain_dev_mode=1	> Grain Deviation: 0(random) or 1(spread)
grain_pan_mode=0	> Grain Pan Mode: 0(fixed) or 1(travel)
loop_list={0,1,2,3,}	> Loop List: Any number of loops available in the BANK wav folder.

SCALES FILE STRUCTURE

The SCALES.CFG file stores all quantization scales used. Once again, these files can also be edited by the user on a computer in a simple text editor, for users not used to programming this file will look a bit cryptic but remember it is important to keep it tidy with all the brackets, commas and other punctuation elements in their correct place. make sure only to change the values and everything else is kept the same way.

SCALES.CFG
Default
CHROMATIC-{ratios-{1,1.05946,1.12246,1.18921,1.25992,1.33483,1.41421,1.49831,1.58740,1.68179,1.78180,1.88775,},per_octave-1}
MAJOR-{ratios-{1,1.12246,1.25992,1.33483,1.49831,1.68179,1.88775,},per_octave-1}
MINOR-{ratios-{1,1.12246,1.18921,1.33483,1.49831,1.58740,1.88775,},per_octave-1}
PENTA MAJOR-{ratios-{1,1.12246,1.25992,1.49831,1.68179,},per_octave-1}
PENTA MINOR-{ratios-{1,1.12246,1.33483,1.49831,1.78180,},per_octave-1}
TIZITA MINOR-{ratios-{1,1.12246,1.18921,1.33483,1.41421,},per_octave-1}
OCTAVES-{ratios-{1,},per_octave-1}
Custom
CHROMATIC-{ratios-{1,1.05946,1.12246,1.18921,1.25992,1.33483,1.41421,1.49831,1.58740,1.68179,1.78180,1.88775,},per_octave-1}
MAJOR-{ratios-{1,1.12246,1.25992,1.33483,1.49831,1.68179,1.88775,},per_octave-1}
MINOR-{ratios-{1,1.12246,1.18921,1.33483,1.49831,1.58740,1.88775,},per_octave-1}
HARMONIC-{ratios-{1,2,3,4,5,6,7,8,9,10,11,12,13,14,15,16,},per_octave-0}
WELL TUNED-{ratios-{1,1.10742,1.12500,1.14844,1.31250,1.29199,1.47656,1.50000,1.53125,1.75000,1.72266,1.96875,},per_octave-1}
PENTA MAJOR-{ratios-{1,1.12246,1.25992,1.49831,1.68179,},per_octave-1}
PENTA MINOR-{ratios-{1,1.12246,1.33483,1.49831,1.78180,},per_octave-1}

Description:

Notice that all notes are defined in ratios, the standard "equal-tempered" scale has each semitone equal to a ratio of the twelfth root of 2, or 1.05946. So, for example, a fifth is 1.05946 to the 7th power (seven semitones in a musical fifth) or 1.49831. All values are approximate numbers rounded to the 5th decimal digit.

$$1 \text{ semitone} = \sqrt[12]{2} = 1.05946 \qquad \text{A fifth} = \left(\sqrt[12]{2}\right)^7 = 1.49831$$

CHROMATIC Ratios & Scale Intervals:

1	=	C	=	Root
1.05946	=	Db	=	minor 2nd
1.12246	=	D	=	Major 2nd
1.18921	=	Eb	=	minor 3rd
1.25992	=	E	=	Major 3rd
1.33483	=	F	=	Perfect 4th
1.41421	=	Gb	=	dim 5th
1.49831	=	G	=	Perfect 5th
1.58740	=	Ab	=	minor 6th
1.68179	=	A	=	Major 6th
1.78180	=	Bb	=	minor 7th
1.88775	=	B	=	Major 7th
2	=	C	=	Octave

For feedback, comments or problems please contact us at:
addac@addacsystem.com